

Uniclass		
L217241		
CI/SfB		
(99.64)	Xh	

April 2011



**GATIC**® Access Covers



**AIC INFRASTRUCTURES PVT. LTD.**

Building Excellence

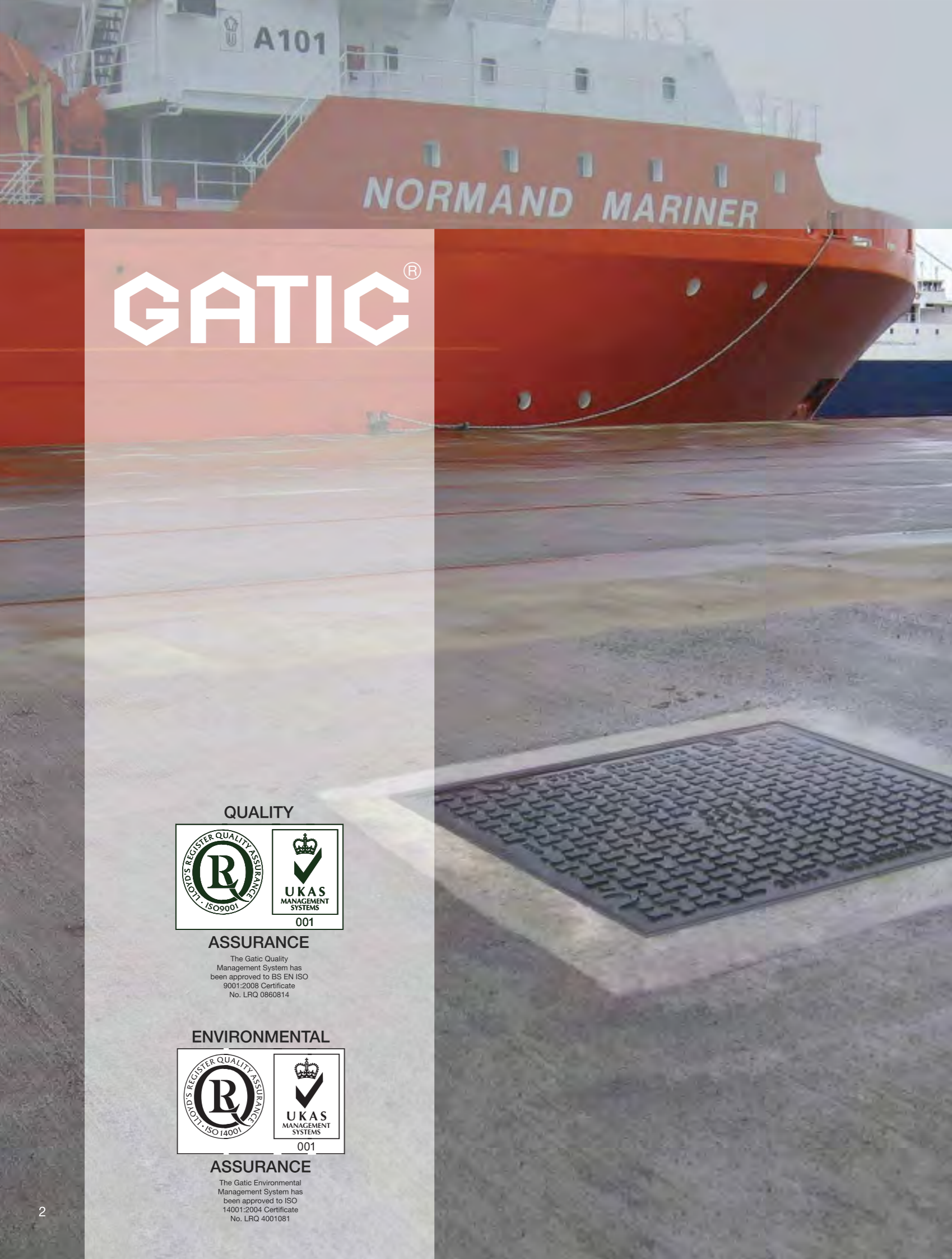

# GATIC®



### ASSURANCE

The Gatic Quality Management System has been approved to BS EN ISO 9001:2008 Certificate No. LRQ 0860814



### ASSURANCE

The Gatic Environmental Management System has been approved to ISO 14001:2004 Certificate No. LRQ 4001081

## Contents

Gatic - Gas and Air Tight Inspection Covers	4
Specialised Engineering, Special Advice	6
An Introduction to Gatic and our Accreditations	8
Loading Group Selector Guide	10
The Gatic Range of Access Covers	12
Product Features and Benefits	14



### Gatic Loading Group B125 Covers and Frames 16-27

Introduction	16
Single covers and frames	18
Duct covers and frames	20
Continuous trench covers and frames	22
Multispan covers and frames	24



### Gatic Loading Group C250 Covers and Frames 28-39

Introduction	28
Single covers and frames	30
Duct covers and frames	32
Continuous trench covers and frames	34
Multispan covers and frames	36



### Gatic Loading Group D400 Covers and Frames 40-51

Introduction	40
Single covers and frames	42
Duct covers and frames	44
Continuous trench covers and frames	46
Multispan covers and frames	48

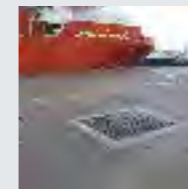

### Gatic Loading Group E600 Covers and Frames 52-63

Introduction	52
Single covers and frames	54
Duct covers and frames	56
Continuous trench covers and frames	58
Multispan covers and frames	60



### Gatic Loading Group F900 Covers and Frames 64-75

Introduction	64
Single covers and frames	66
Duct covers and frames	68
Continuous trench covers and frames	70
Multispan covers and frames	72



### Special Products, Gratings and frames 76-84

### Installation 85-90

### Lifting keys 91



Gas Air Tight Inspection Covers

A challenge in the twenties. Still challenging today.



Back in 1928, we must have got something right with our gas and air tight inspection covers.



Because, after over 80 years of continuous development, we're still making them.

With a history of installations dating back more than eighty years, Gatic is without doubt the fully proven International Standard for engineered access covers and drainage gratings.

industry and commerce, developing ductile iron, machined access covers in a range of surface finishes and load ratings to cope with the harshest and most punishing of environments.

#### Original 1928 cover still in use

When we were asked to design our first gas and air tight cover for Shell, back in the 20s, it was to a demanding specification. Our success in meeting this specification can be judged by the fact that one of the first covers supplied can still be seen in use at a Shell garage in Malta where it was originally installed.

#### Future challenges

Despite this huge variety, technology never stands still for long and we are never allowed to rest on our laurels. These days more and more traffic is using our roads, carrying heavier loads at higher speeds. Huge numbers of containers pass through our ports daily and ever bigger and heavier aircraft are rolling down the taxiways and across the aprons of the airports we serve.

#### Continuous development and refinement

Since that first success we have continued to improve and adapt our range of products to suit the ever increasing and diverse demands of travel,

The challenges may be daunting but we are confident that we will continue to rise to the occasion and supply products to meet or exceed our customers demands.

### Best products. Best advice. Best results.

At Gatic, we know that our reputation is only as good as the performance of our products. So we do our very best to ensure that the product you buy is the right product for the job and that it is installed correctly in order to be able to do its job successfully. That is why we make a point of supplying all the help and technical support that we can.

### Manufacturing standards

It all starts with the manufacturing process. All the basic components for Gatic covers are cast to exacting specifications, developed over time.

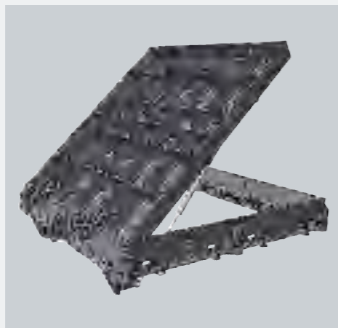

The composition of the ductile iron is tightly controlled and the tolerances of the actual casting process are held to fine and demanding limits.



This is because our products will eventually be machined to tight specifications in order to achieve the gas, air-tight and non-rocking fit upon which our reputation is built.

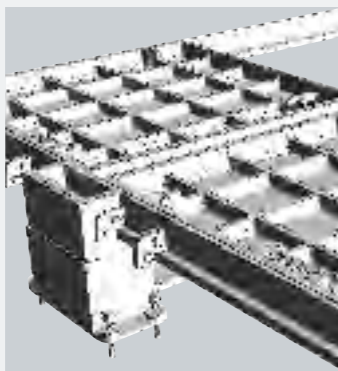

Gatic covers are produced in a wide range of strength ratings to suit any real-life application.

When correctly installed, they can be expected to continue to perform as intended for the lifetime of the project, with minimal servicing. Our covers are designed to work effectively in the harshest environments.

Details of the range of load factors to match your requirements can be found on pages 10-11 of this publication. Selecting the appropriate product for your intended application means that you will achieve the service life and performance you need without over specifying, thus ensuring that you get the product you need with the most beneficial ratio of strength to cost. We can help you with this selection process and regard it as a very important part of our service.

### Professional advice on your project

Our design engineers are available to discuss the technical aspects of any project involving Gatic covers, whether large or small. The application of a little expert knowledge often means that what appear to be intractable problems can be overcome with relative ease.

You can tap into this expertise either through our website [www.gatic.com](http://www.gatic.com) or by calling **+44 (0)1304 203 545**. You will find most of the information you need to narrow down the choice of covers for your particular project within the pages of this publication. To see in detail how Gatic covers are constructed and fitted on site, we suggest you go to the website, where much more information is available.

### Downloads and tutorials

On the Gatic website, you will find a link to Access Cover Tutorials. Follow this link and you will be taken stage by stage through the assembly and installation process for a multispan engineered access cover, including the preparation of the

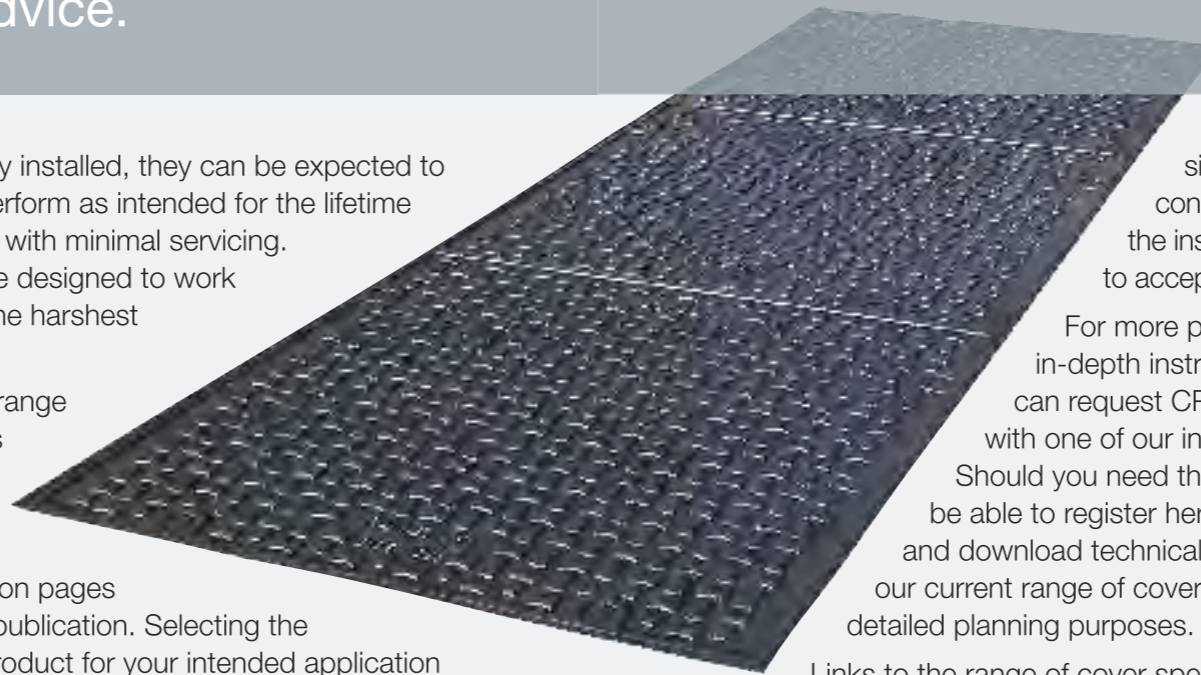

site and construction of the inspection pit to accept the cover.

For more personal, in-depth instruction, you can request CPD training with one of our instructors. Should you need them, you will be able to register here to access and download technical drawings of our current range of covers for more detailed planning purposes.

Links to the range of cover specifications by load-bearing criteria, showing typical applications and other considerations influencing the choice of cover for each particular project are also to be found.



### Specialist advice and assistance

If your project throws up some particularly challenging problem which needs an in-depth understanding, please don't hesitate to get in touch since, in all probability, we have

encountered a similar challenge before and, even if this is not the case, our 80-plus years of experience in dealing with these issues are sure to help you reach a satisfactory resolution.

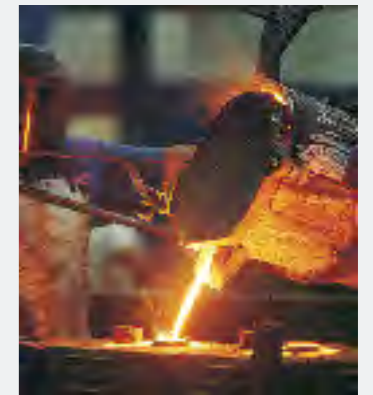

Once these choices have been made you can relax, safe in the knowledge that your covers will be delivered to site in a timely manner.

### Pre-delivery assembly

All Gatic products are pre-assembled and quality checked prior to dispatch from our factory.

This process not only assures us that our cover is up to specification and worthy of the Gatic name, but means that our customers can expect it to perform in service to the high standards they have a right to expect and to continue to do so long into the future.





# An Introduction to Gatic and our Accreditations

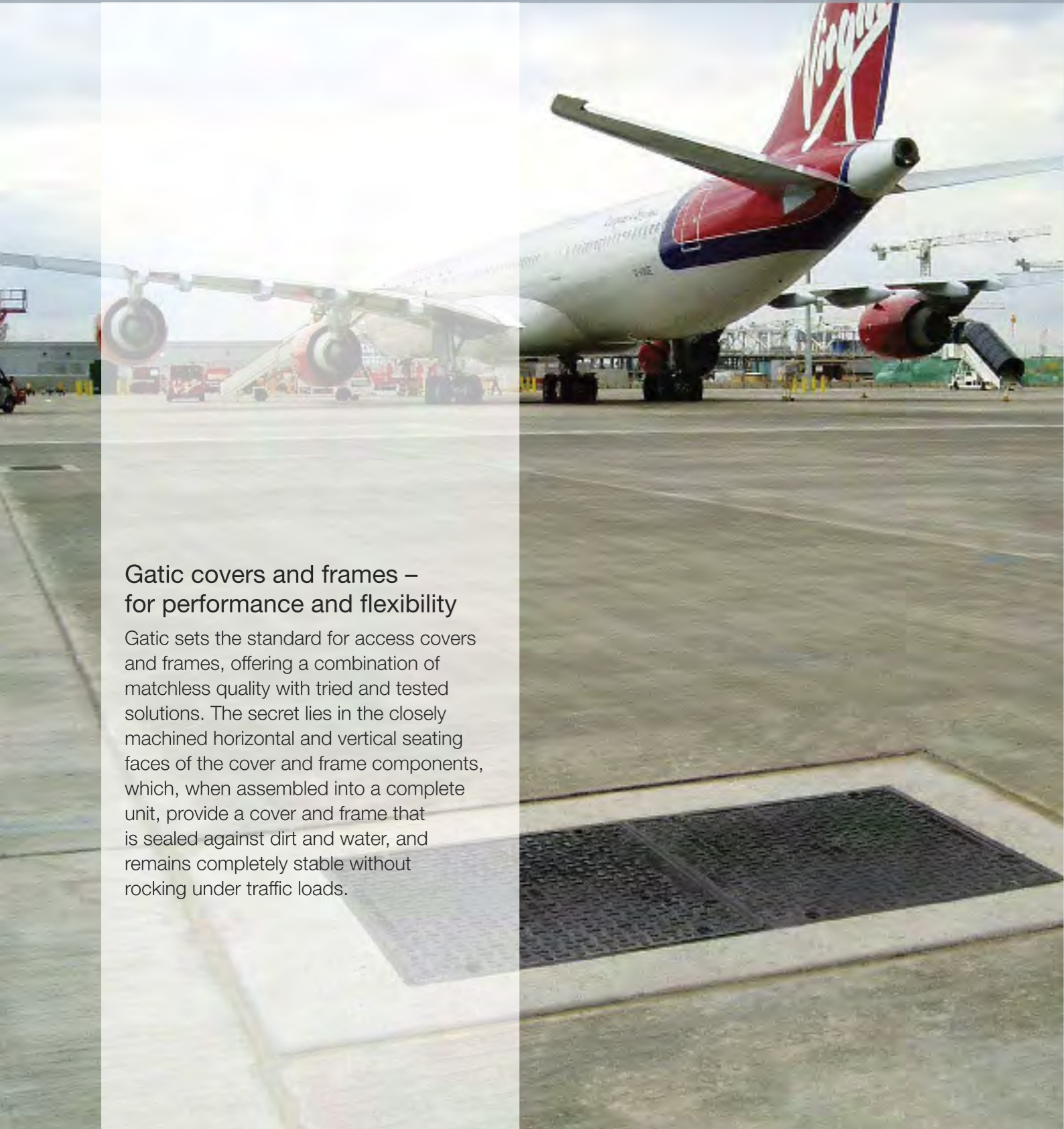

## Gatic covers and frames – for performance and flexibility

Gatic sets the standard for access covers and frames, offering a combination of matchless quality with tried and tested solutions. The secret lies in the closely machined horizontal and vertical seating faces of the cover and frame components, which, when assembled into a complete unit, provide a cover and frame that is sealed against dirt and water, and remains completely stable without rocking under traffic loads.

Gatic covers are designed both to protect and give easy access to a diverse range of underground services, examples include:

- Manhole/Pump/Valve/Transformer Chambers
- Pipe and Cable service Trenches
- Cable Draw Pits
- Lighting Pits
- Fuel and Fire Hydrant Pits
- Machinery/Plant Access Chambers
- Combined Sewer/Overflow Chambers

Typical applications can be found in a diverse range of projects including:

- Airports
- Ports/Docks
- Utilities - Gas/Electricity
- Water - Sewerage Treatment Works/ Water Treatment Works/Pumping Stations
- Power Stations/Sub-Stations
- Commercial and Industrial Applications
- Highways
- Tunnels

### Cover options

Gatic covers are available in a choice of designs to suit different conditions and requirements for appearance.

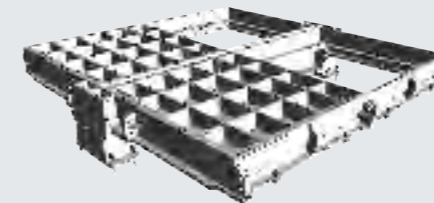

#### Recessed for concrete infill

Covers are designed with an arrangement of cross-ribs for infilling with concrete. This provides a very strong and hardwearing surface with an attractive appearance.

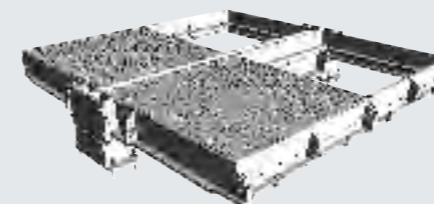

#### Solid top anti-slip surface

High performance covers that are lighter in weight than those incorporating concrete infill. Solid top covers incorporate a raised lozenge pattern on the surface.

### Quality Assurance

The Gatic Quality Management System has been approved to BS EN ISO 9001:2008 Certificate Number LRQ 0860814

The Gatic Environmental Management System has been approved to ISO 14001:2004 Certificate Number LRQ 4001081



Our products are manufactured from 100 per cent ductile iron, giving high elasticity, which means Gatic covers and frames are highly resistant to physical forces and shock.

Gatic covers comprise ductile iron and structural steel components, all of which are recyclable.

### Using this brochure

Gatic covers have been created to suit the widest range of applications and to meet different loading requirements, from relatively light loads (eg, pedestrian areas and residential roads) to the most heavy (eg, airports, dockyards, etc).

BS EN 124:1994 classifies covers according to their place of installation as shown below. Where there is any doubt, the stronger class should be selected.

Loading description	BS EN 124	
	Class	Test Load
Footways, pedestrian areas, etc	B125	125kN
Gully tops in kerbside channels of roads	C250	250kN
Carriageways of roads (heavy duty)	D400	400kN
Areas imposing high wheel loads	E600	600kN
Areas imposing particularly high wheel loads	F900	900kN

Data from BS EN 124:1994 (Gully tops and manhole tops for vehicular and pedestrian areas. Design requirements, type testing, marking, quality control)

The covers in our brochure are organised according to the BS EN 124 classifications. Please refer to the Loading Group Selector Guide on pages 10-11.



### Loading Group Gatic B125

3 tonne wheel load - test load 125kN

- Footways
- Pedestrians areas
- Car parks
- Driveways
- Internal floors

Pages 16 - 27

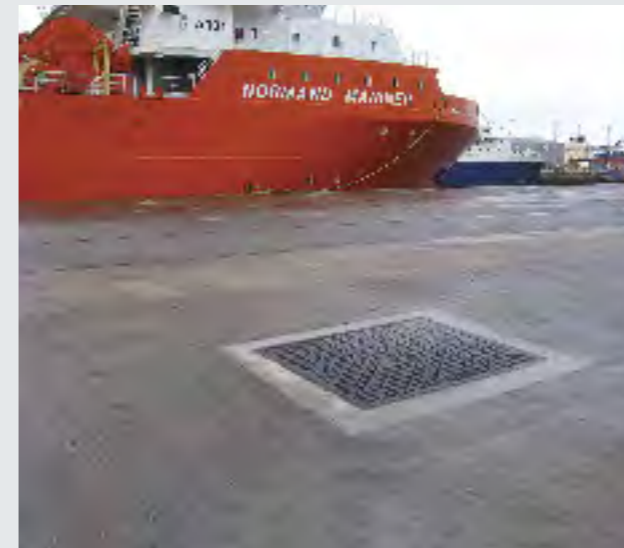

### Loading Group Gatic E600

20 tonne slow moving wheel load - test load 600kN

- Areas imposing high wheel loads:
- Some airfield pavements
  - Dockyards
  - Other areas where single slow moving wheel loads up to 20 tonne may be encountered

Pages 52 - 63



### Loading Group Gatic C250

5 tonne wheel load - test load 250kN

Roads for relatively slow moving traffic, ie:

- Minor residential
- Cul-de-sacs
- Pedestrian precincts
- Yard

Pages 28 - 39



### Loading Group Gatic F900

In excess of 20 tonne slow moving wheel load - test load 900kN

- Areas imposing particularly high wheel loads:
- Airfield pavements
  - Taxiways
  - Civil airports
  - Container ports
  - Dockyards
  - Other areas where single slow moving wheel loads may exceed 20 tonne

Pages 64 - 75



### Loading Group Gatic D400

11.5 tonne wheel load - test load 400kN

- Power stations
- Carriageways
- Hard shoulders
- Parking areas for all vehicle types

For high density traffic conditions we recommend the use of a vibration resistant locking system

Pages 40 - 51



The Gatic range of loading groups is organised according to BS EN 124:1994 (*Gully tops and manhole tops for vehicular and pedestrian areas. Design requirements, type testing, marking, quality control*).



# The Gatic Range of Access Covers

Single Covers and Frames



Duct Covers and Frames

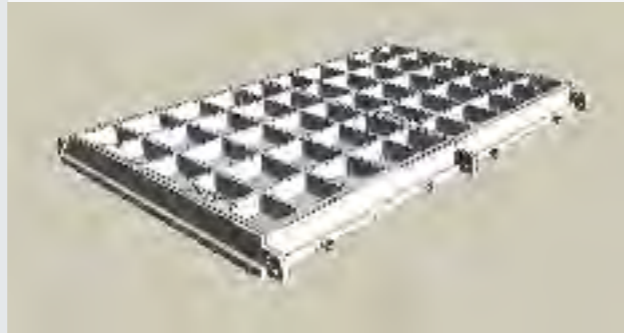

Continuous Trench Covers and Frames



Multispan Covers and Frames



### Cover types

Covers are recessed for concrete infill or solid top according to specifier preference.

### Concrete infill recessed covers

Recessed covers are designed for filling with concrete as specified in BS EN 124 - C45- 45 N/mm<sup>2</sup> for a test cube of 150mm, or a 40N/mm<sup>2</sup> for a test cylinder 150mm diameter x 300mm high, using a 10mm coarse aggregate.

### Anti-slip surface covers

Concrete infill covers provide a non-slip surface similar to the surrounding areas. Solid top covers incorporate a raised lozenge pattern on the surface.

### Materials

The components of Gatic covers are manufactured from the following materials:

Ductile iron components to BS EN 1563:1997

Structural steel sections (removable beams) to BS 4-1:2005

### Fine tolerances

The seating faces of Gatic covers and frames are machined to ensure metal-to-metal contact within 0.25mm tolerance.

### Non-rocking

Correctly installed, Gatic covers will be non-rocking under traffic and sealed against ingress of road dirt and other detritus.

### Watertight

A film of graphite grease between the contact faces of Gatic units provides a gas and airtight seal, and a watertight joint under normal rainwater conditions.

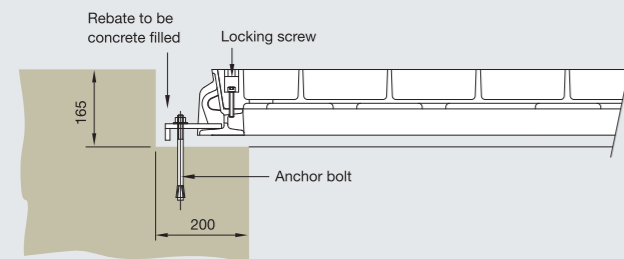

Watertightness under pressure

### Pressure-tight

Standard single units with locking screws and holding-down bolts are available to withstand upward pressure. Consult our technical department for details.

### Easy removal/replacement

The machined underside seating face of Gatic covers allows the sliding out of covers for easy removal or replacement.

### Operator control

Jack screw operating keys locate positively and securely into Gatic covers and are a necessary tool if the inherent cover seal is to be broken effectively and to allow operator maximum control during operation.

### Secure and vandal resistant

Covers are designed to prevent tampering and unauthorised removal. Gatic covers cannot be removed without the correct lifting key, so unauthorised removal is virtually impossible. Locking bolts can be fitted to Gatic cover keyways as an additional security feature.

### Ventilation

Ventilation can be provided by fitting four 25mm diameter ventilation tubes in recessed covers.

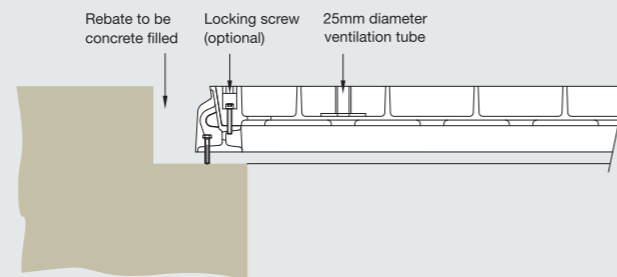

Locking/ventilated

### Vibration resistant

To prevent movement of covers in high density traffic conditions, we recommend the use of a factory-fitted vibration-resistant locking system. Can be fitted to recessed covers only.

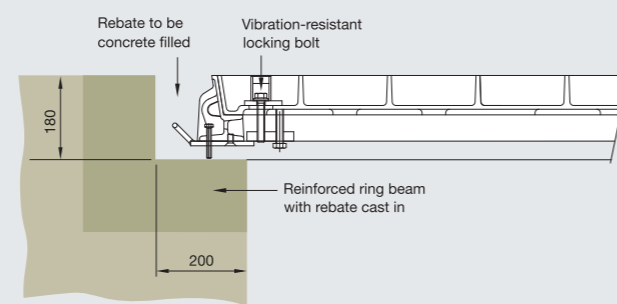

Vibration resistant

We do not recommend the use of solid top covers in high density traffic locations.

### Closed keyways

Gatic cover keyways are closed and fitted with plastic plugs to prevent them from blocking up.

### Loadings

All Gatic covers will withstand test load, deflection and maximum deformation criteria specified in BS EN 124 for each loading category.

### Frame bars

Gatic 140mm deep supporting frames incorporate an 'I' beam design profile to provide a robust and rigid frame that will withstand the specified loads, without any concrete infill or backfill.

### Rigidity

The robust and rigid design of Gatic D400, E600 and F900 frames, combined with close manufacturing tolerances, provides a monolithic structure that will withstand the dynamic effects of traffic movement and impact.

### Secure support

The clear opening width between supporting frames are at least 10mm greater than the pit/chamber design to allow for minor deviations in pit construction dimensions.

### Beam wallbox

Supporting beams in Gatic Multispan units are easily removed with appropriate lifting equipment for access to the total chamber area. Beam wallboxes do not project into the chamber opening.

### Finishes

Units are coated with a black bituminous solution that acts as a temporary protection during transit. Removable supporting steelwork is galvanised to BS EN ISO 1461:2009. See page 80 for alternative finishes.

### Installation

Consignments of Gatic units are accompanied by comprehensive installation instructions.

### Levelling bolts

All side frame bars and wallboxes are fitted with bolts to assist in the levelling of the unit during installation.

### Safety grids

Hinged lift-out galvanised steel safety grids (with padlock facility if required) can be incorporated into Gatic units. See page 80.

### Environmental commitment

Responsibility towards the environment is our primary concern. Our customers often now demand products that are made from recycled and recyclable materials, supplied by companies with robust environmental policies to reduce the environmental impact of their projects for future generations.

To meet these requirements we have an integrated Quality (BS EN 9001:2008) and Environmental (ISO 14001:2004) Management System which encompasses the design, manufacture and management systems within the company and ensures our commitment to continuous environmental improvements regarding the manufacture and design of all our products in the following ways:

- Minimise environmental impact
- Commit organisational resources to energy management
- Reduce energy costs
- Give high priority to energy efficient investments
- Consider life cycle energy costs for all new projects
- Minimise CO<sub>2</sub> emissions year on year
- Use energy from sustainable resources wherever possible

To achieve these goals we have put in place the necessary systems and controls to meet demanding environmental targets and to make sure that these are maintained for the future benefit of the environment and our customers alike.

### Gatic services

Gatic offers a full support service to specifiers and contractors, including Computer Aided Design. AutoCAD compatible details of all Gatic products are available. Please consult our technical department for assistance.

In view of our commitment to product improvement, we reserve the right to alter designs without notice. Design changes will not adversely affect the performance or loading capability of our products.

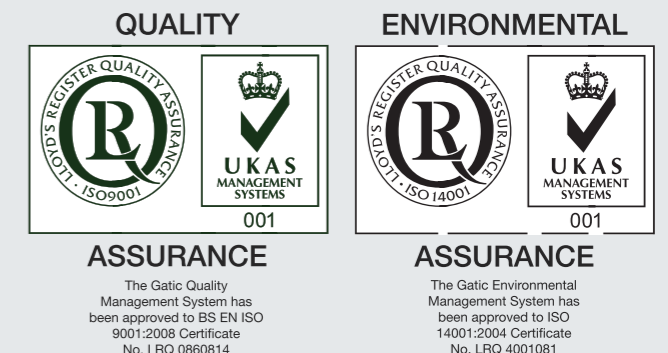





# GATIC Loading Group B125

## Introduction

This section includes Gatic covers and frames designed for Loading Group B125.

3 tonne wheel load, test load  
125kN – Suitable for:

- Footways
- Pedestrian areas
- Car parks
- Driveways
- Internal floors

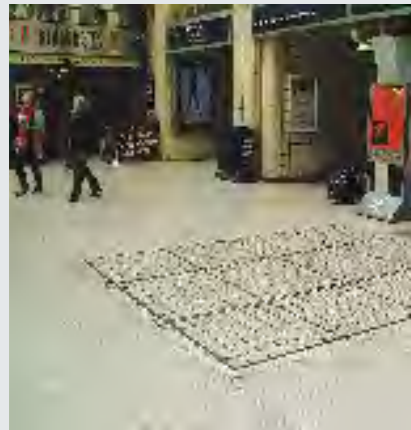

B125 assemblies are available with a choice of cover designs – recessed or solid top.

### Recessed for concrete infill

Recessed covers are available in a choice of designs designated by a 'Type' reference. B125 recessed covers are available as Type DL, DLF and DM. Section drawings of the different recessed cover types are shown on the following pages.



### Solid top

Solid top cover types are lighter in weight than recessed covers, and feature a figured anti-slip surface. Solid top covers are denoted by the code Type DLS and DMS depicted in section on the following pages.

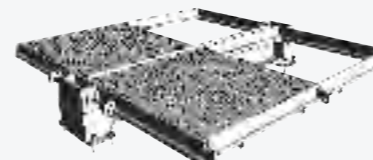

## Cover types

Single covers and frames



Duct covers and frames



Continuous trench covers and frames



Multispan covers and frames



If you are uncertain as to the adequacy of covers conforming to a particular loading, we recommend specifying covers in a higher loading group. For example, if in doubt about covers in Loading Group B125, we recommend you specify covers in Loading Group C250.





# GATIC

## Single recessed covers and frames



Covers recessed for concrete infill

Cover types: DLF, DL, DM

To specify state:

1. Loading group
2. Pit clear opening size length (L) x span (S)
3. Cover type



Pit clear opening sizes	Cover type	Overall frame size length x width x depth	Suggested rebate size length x width x depth
750 x 300	DLF	900 x 540 x 75	1050 x 600 x 100
600 x 450	DL	750 x 690 x 75	900 x 750 x 100
750 x 450	DL	900 x 690 x 75	1050 x 750 x 100
600 x 600	DL	770 x 840 x 75	900 x 900 x 100
750 x 600	DL	920 x 840 x 75	1050 x 900 x 100
900 x 600	DL	1070 x 840 x 75	1200 x 900 x 100
750 x 750	DL	920 x 990 x 75	1050 x 1050 x 100
900 x 750	DL	1070 x 990 x 75	1200 x 1050 x 100
900 x 900	DL	1120 x 1140 x 75	1200 x 1200 x 100
600 x 1050	DL	850 x 1290 x 75	900 x 1350 x 100
750 x 1050	DL	1000 x 1290 x 75	1050 x 1350 x 100
1000 x 1050	DM	1220 x 1270 x 140	1400 x 1450 x 165
600 x 1200	DM	820 x 1420 x 140	1000 x 1600 x 165
750 x 1200	DM	970 x 1420 x 140	1150 x 1600 x 165

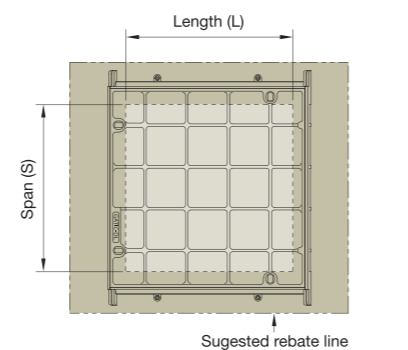

Plan of recessed single cover

## Single solid top covers and frames



Covers with solid top

Cover types: DLS, DMS

To specify state:

1. Loading group
2. Pit clear opening size length (L) x span (S)
3. Cover type



Pit clear opening sizes	Cover type	Overall frame size length x width x depth	Suggested rebate size length x width x depth
600 x 600	DLS	770 x 840 x 75	900 x 900 x 100
750 x 600	DLS	920 x 840 x 75	1050 x 900 x 100
900 x 600	DLS	1070 x 840 x 75	1200 x 900 x 100
750 x 750	DLS	920 x 990 x 75	1050 x 1050 x 100
900 x 750	DLS	1070 x 990 x 75	1200 x 1050 x 100
900 x 900	DLS	1120 x 1140 x 75	1200 x 1200 x 100
600 x 1200	DMS	750 x 1420 x 140	1000 x 1600 x 165
750 x 1200	DMS	900 x 1420 x 140	1150 x 1600 x 165
1000 x 1000	DMS	1220 x 1220 x 140	1400 x 1400 x 165

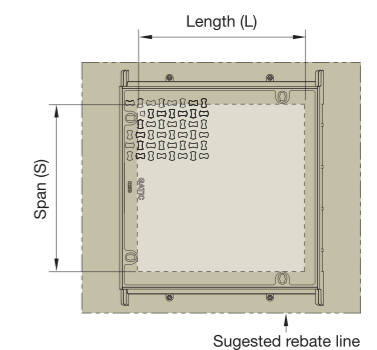

Plan of solid top single cover

### Cover types

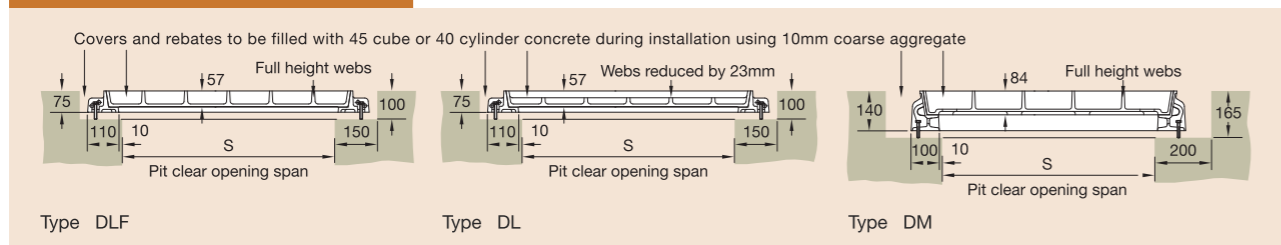

### Cover types

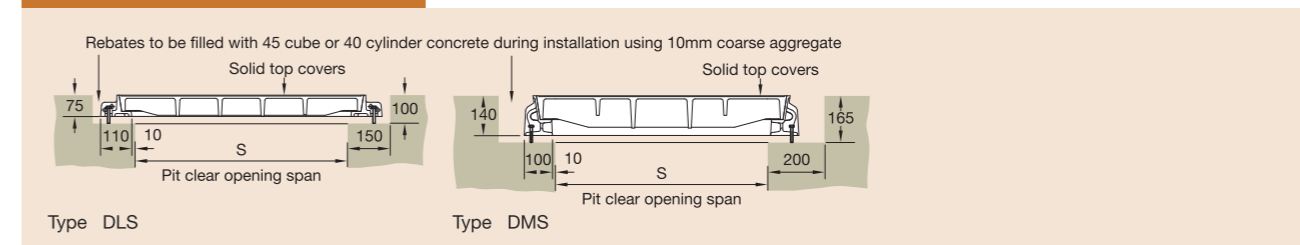



# GATIC

## Recessed duct covers and frames



Covers recessed for concrete infill

Cover types: DLF, DL, DM

To specify state:

1. Loading group
2. Pit clear opening size length (L) x span (S)
3. Cover type

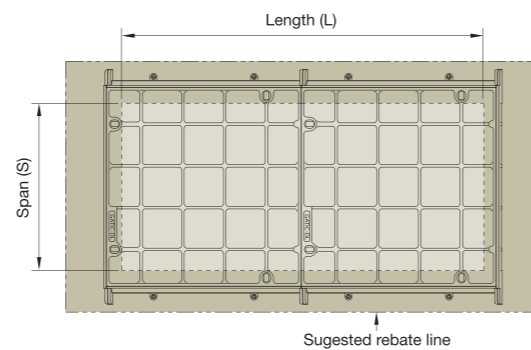

Plan of recessed duct cover

Pit clear opening sizes	Cover type	Suggested rebate size length x width x depth
300	DLF	(L + 300) x 600 x 100
450	DL	(L + 300) x 750 x 100
600	DL	(L + 300) x 900 x 100
750	DL	(L + 300) x 1050 x 100
900	DL	(L + 300) x 1200 x 100
1050	DL	(L + 300) x 1350 x 100
1200	DM	(L + 400) x 1600 x 165
1350	DM/F	Refer to our technical department
1500	DM/F	Refer to our technical department

Pit clear opening span (S)	Cover type	Standard pit clear opening length (L)											
		1300	1450	1600	1750	1900	2000	2150	2300	2450	2600	2700	2750
300	DLF	*	*	2	*	*	*	*	*	3	*	*	*
450	DL	2	2	2	2	*	3	3	3	3	*	4	*
600	DL	2	2	2	2	2	3	3	3	3	3	4	3
750	DL	2	2	2	2	2	3	3	3	3	3	4	3
900	DL	2	2	2	2	2	3	3	3	3	3	4	3
1050	DL	2	2	2	*	*	3	3	3	3	*	4	*
1200	DM	2	2	2	*	*	3	3	3	3	*	4	*

Pit clear opening span (S)	Cover type	Standard pit clear opening length (L)											
		2850	2900	3000	3150	3300	3400	3550	3700	3850	3900	4000	4150
300	DLF	*	*	*	*	4	*	*	*	*	*	*	5
450	DL	4	*	4	4	4	5	5	5	5	*	5	5
600	DL	4	3	4	4	4	5	5	5	5	4	5	5
750	DL	4	3	4	4	4	5	5	5	5	4	5	5
900	DL	4	3	4	4	4	5	5	5	5	4	5	5
1050	DL	4	*	4	4	4	5	5	5	5	*	5	5
1200	DM	4	*	4	4	4	5	5	5	5	*	5	5

\* Indicates standard sizes not available. The number shown indicates the quantity of cover parts. Other standard sizes may be available, refer to our technical department.

### Cover types

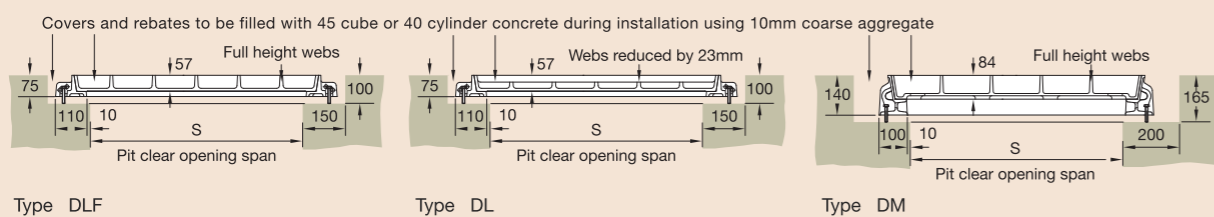

## Solid top duct covers and frames



Covers with solid top

Cover types: DLS, DMS

To specify state:

1. Loading group
2. Pit clear opening size length (L) x span (S)
3. Cover type

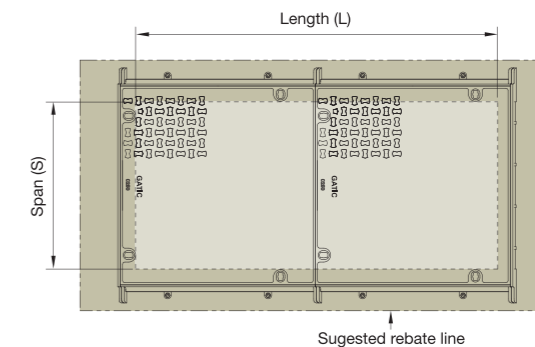

Plan of solid top duct cover

Pit clear opening sizes	Cover type	Suggested rebate size length x width x depth
600	DLS	(L + 300) x 900 x 100
750	DLS	(L + 300) x 1050 x 100
900	DLS	(L + 300) x 1200 x 100
1200	DMS	(L + 400) x 1600 x 165

Pit clear opening span (S)	Cover type	Standard pit clear opening length (L)											
		1300	1450	1600	1750	1900	2000	2150	2300	2450	2600	2700	2750
600	DLS	2	2	2	2	2	3	3	3	3	3	4	3
750	DLS	2	2	2	2	2	3	3	3	3	3	4	3
900	DLS	2	2	2	2	2	3	3	3	3	3	4	3
1200	DMS	2	2	2	*	*	3	3	3	3	*	4	*

Pit clear opening span (S)	1200	Standard pit clear opening length (L)											
		2850	2900	3000	3150	3300	3400	3550	3700	3850	3900	4000	4150
600	DLS	4	3	4	4	4	5	5	5	5	4	5	5
750	DLS	4	3	4	4	4	5	5	5	5	4	5	5
900	DLS	4	3	4	4	4	5	5	5	5	4	5	5
1200	DMS	4	*	4	4	4	5	5	5	5	*	5	5

\* Indicates standard sizes not available. The number shown indicates the quantity of cover parts. Other standard sizes may be available, refer to our technical department.

### Cover types

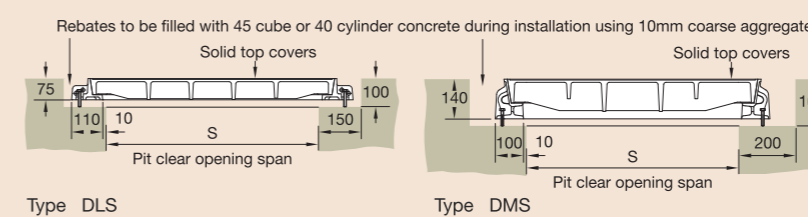



# GATIC

## Continuous recessed trench covers and frames



Covers recessed for concrete infill

Cover types: DL, DLF, DM, DM/F

To specify state:

1. Loading group
2. Cover type
3. Supply layout drawing of trenches

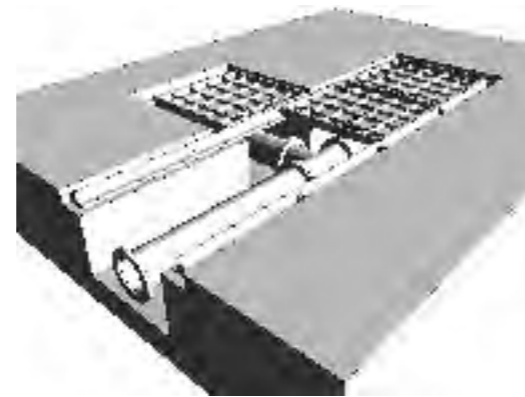

### Continuous recessed cover

Pit clear opening span	Cover type
300	DLF
450	DL
600	DL
750	DL
900	DL
1050	DL
1200	DM
1350	DM/F
1500	DM/F

Note: For type DM/F refer to our technical department

Gatic covers can be formed to make continuous trenches or layouts providing total access to services below.

Construction drawings are required so that Gatic cover layout drawings can be prepared.

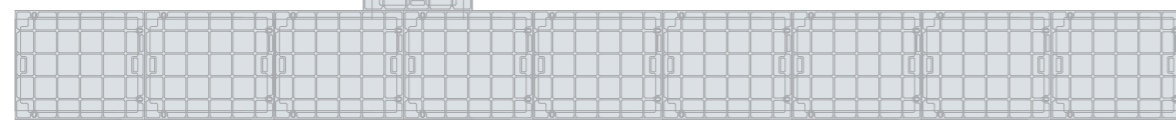

### Cover types

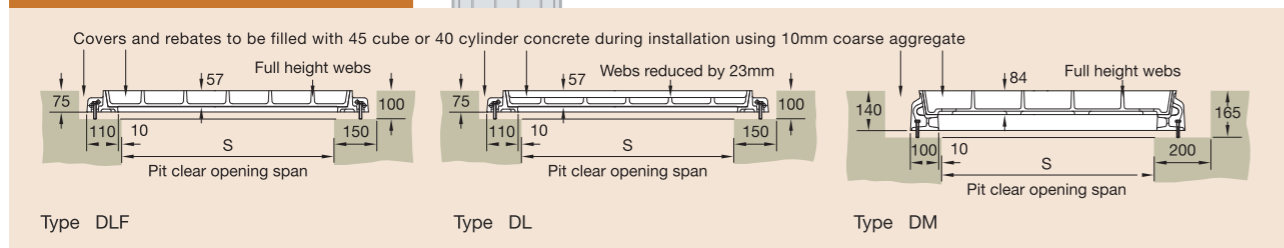

## Continuous solid top trench covers and frames

Covers with solid top

Cover types: DLS, DMS

To specify state:

1. Loading group
2. Cover type
3. Supply layout drawing of trenches

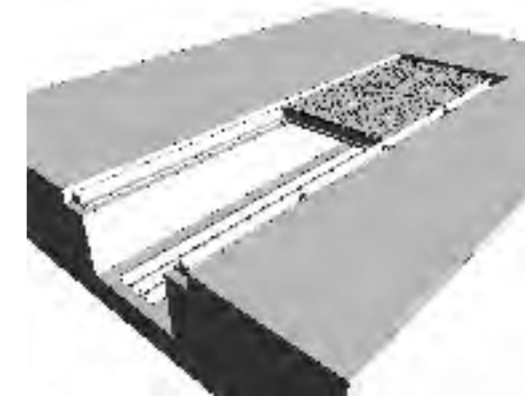

### Continuous solid top cover

Pit clear opening span	Cover type
600	DLS
750	DLS
900	DLS
1200	DMS

Standard solid top covers are supplied in straight runs. Junctions and splays can be achieved by the inclusion of localised recessed covers. Refer to our technical department for more information.

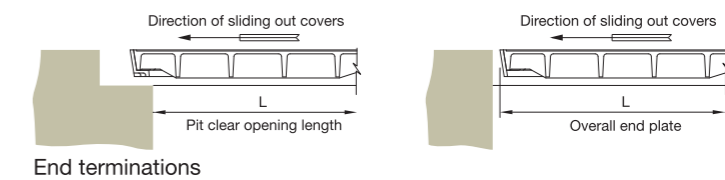

### Cover types

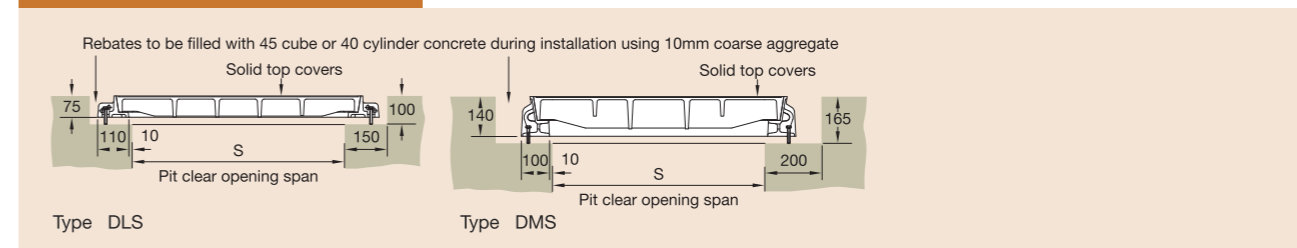



# GATIC

## Multispan covers and frames

### Specification

Below is sample specification information and notes for Multispan recessed covers and frames.

For more details on features and benefits of Gatic covers, see pages 14 to 15.

#### Loading group Gatic B125

3 tonne wheel load – test load 125 kN.

#### Materials

Ductile iron components to BS EN 1563:1997.

Structural steel removable beams to BS 4-1:2005.

#### Finishes

Units coated with black bituminous solution for protection during transit.

Removable supporting steelwork galvanised to BS EN ISO 1461:2009.

#### Infill and surround concrete by customer

Concrete strength, using 10mm coarse aggregate, to be:

45N/mm<sup>2</sup> for a test cube of 150mm or

40N/mm<sup>2</sup> for a test cylinder of 150mm diameter x 300mm high.

#### Installation

In accordance with instructions supplied by Gatic.



Type DL recessed



Type DLS solid top

To specify use size and description format as follows:

#### Gatic Multispan Recessed covers and frames Cover type DL recessed

Multiple access covers recessed for concrete infill with removable beams.

.... in no. .... (length) x .... (span) mm pit clear opening multi span cover and frame.

Gatic Type DL Ductile Iron Recessed Cover in .... parts complete with

.... in no. .... x .... mm galvanised removable support beam spanning the .... (length) mm way.

Suitable for Loading Group B125 – Medium/Light Duty 3 Tonnes Wheel Load (pneumatic tyre).

#### Gatic Multispan Solid Top covers and frames Cover type DLS solid top

Multiple solid top access covers with removable beams.

.... in no. .... (length) x .... (span) mm pit clear opening multi span cover and frame.

Gatic Type DLS Ductile Iron Solid Top Cover in .... parts complete with

.... in no. .... x .... mm galvanised removable support beam spanning the .... (length) mm way.

Suitable for Loading Group B125 – Medium/Light Duty 3 Tonnes Wheel Load (pneumatic tyre).

Standard pit clear opening sizes are shown on Page 25.

Beam sizes and other dimensions are shown on Pages 26 and 27.

## Multispan covers and frames

### Product Selection

Refer to the table to identify which cover and beam configuration you require against pit clear opening length (L) and pit clear opening span (S). All dimensions are in millimetres.

		Pit clear opening length (L) mm												Beam centres mm																
		2 parts					3 parts				4 parts			A	B	C	D	E												
		1300	1450	1600	1750	1900	2000	2150	2300	2450	2600	2750	2900	2700	2850	3000	3150	3300	3450	3600	3750	3900								
2 parts	1 beam	S		L		S		L		S		L		S		L		S		L		690	690							
	1380	S		L		S		L		S		L		S		L		S		L		690	690							
	1530	S		L		S		L		S		L		S		L		S		L		840	690							
	1680	S		L		S		L		S		L		S		L		S		L		840	840							
	1830	S		L		S		L		S		L		S		L		S		L		990	840							
1980	S		L		S		L		S		L		S		L		S		L		990	990								
		4 part (2x2) recessed multispan cover with 1 removable support beam					6 part (3x2) recessed multispan cover with 1 removable support beam				8 part (4x2) recessed multispan cover with 1 removable support beam																			
3 parts	2 beams	S			L			S			L			S			L			S			L			690	780	690		
	2160	S			L			S			L			S			L			S			L			690	780	690		
	2310	S			L			S			L			S			L			S			L			690	930	690		
	2460	S			L			S			L			S			L			S			L			840	780	840		
	2610	S			L			S			L			S			L			S			L			840	930	840		
2760	S			L			S			L			S			L			S			L			840	1080	840			
2910	S			L			S			L			S			L			S			L			990	930	990			
3060	S			L			S			L			S			L			S			L			990	1080	990			
		6 part (2x3) recessed multispan cover with 2 removable support beams					9 part (3x3) recessed multispan cover with 2 removable support beams				12 part (4x3) recessed multispan cover with 2 removable support beams																			
4 parts	3 beams	S		L		S		L		S		L		S		L		S		L		S		L		690	780	780	690	
	2940	S		L		S		L		S		L		S		L		S		L		S		L		840	780	780	690	
	3090	S		L		S		L		S		L		S		L		S		L		S		L		840	780	780	840	
	3240	S		L		S		L		S		L		S		L		S		L		S		L		840	930	930	690	
	3390	S		L		S		L		S		L		S		L		S		L		S		L		840	930	930	840	
3540	S		L		S		L		S		L		S		L		S		L		S		L		990	930	930	840		
3690	S		L		S		L		S		L		S		L		S		L		S		L		990	930	930	990		
3840	S		L		S		L		S		L		S		L		S		L		S		L		990	930	930	990		
3990	S		L		S		L		S		L		S		L		S		L		S		L		990	1080	1080	840		
4140	S		L		S		L		S		L		S		L		S		L		S		L		990	1080	1080	990		
		8 part (2x4) recessed multispan cover with 3 removable support beams					12 part (3x4) recessed multispan cover with 3 removable support beams				16 part (4x4) recessed multispan cover with 3 removable support beams																			
5 parts	4 beams	S			L			S			L			S			L			S			L			690	780	780	780	690
	3720	S			L			S			L			S			L			S			L			690	780	930	780	690
	3870	S			L			S			L			S			L			S			L			840	780	780	840	
	4020	S			L			S			L			S			L			S			L			690	930	930	930	690
	4170	S			L			S			L			S			L			S			L			840	930	780	930	840
4320	S			L			S			L			S			L			S			L			840	930	930	930	840	
4470	S			L			S			L			S			L			S			L			840	930	930	930	840	
4620	S			L			S			L			S			L			S			L			840	930	1080	930	840	
4770	S			L			S			L			S			L			S			L			990	930	930	930	990	
4920	S			L			S			L			S			L			S			L			990	930	1080	930	990	
5070	S			L			S			L			S			L			S			L			990	1080	930	1080	990	
5220	S			L			S			L			S			L			S			L			990	1080	1080	1080	990	
		10 part (2x5) recessed multispan cover with 4 removable support beams					15 part (3x5) recessed multispan cover with 4 removable support beams				20 part (4x5) recessed multispan cover with 4 removable support beams																			

Note: For other pit clear opening sizes please refer to our technical department



# GATIC

## Multispan covers and frames

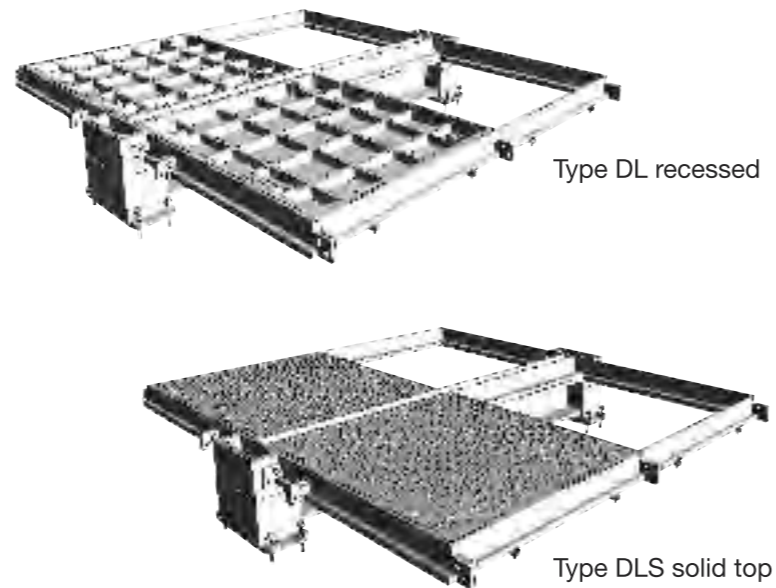

Covers recessed for concrete infill or solid top

Cover types: DL (recessed)  
DLS (solid top)

The details below show plan and sections of a typical recessed/solid top unit.

For selection and specification guidance, refer to pages 24, 25 and 27.

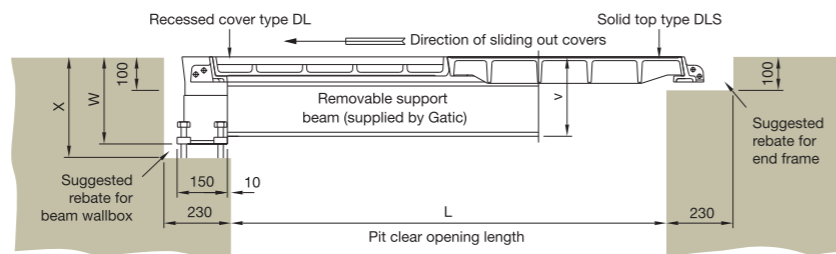

Section A - A

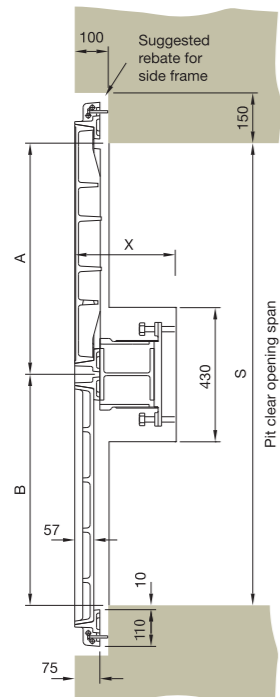

Section B - B

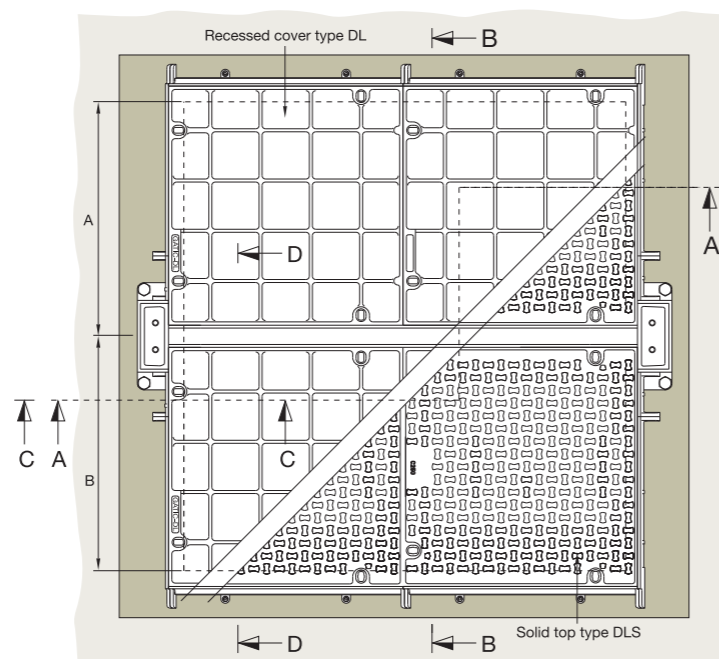

Plan showing recessed and solid top cover options

## Multispan covers and frames

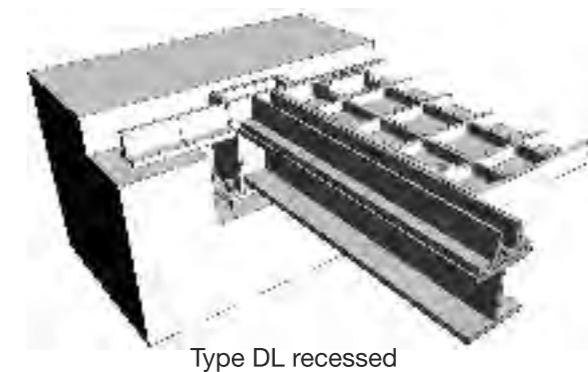

Type DL recessed

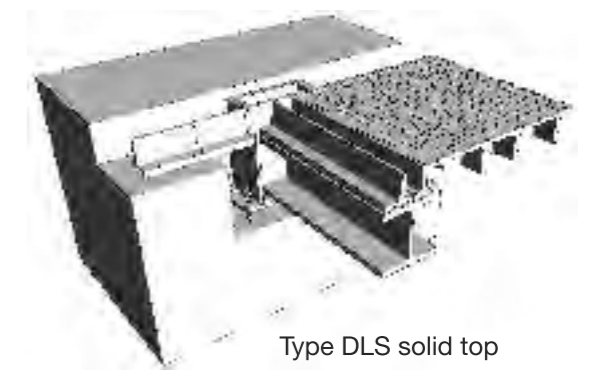

Type DLS solid top

### Beam Size

The required beam size for Multispan covers is dependent on the pit clear opening length and the loading group.

The table shows maximum beam length against beam size. The removable support beams are supplied by Gatic.

The table also indicates dimensions of the beam wallbox and rebate to suit different beam sizes. See also the accompanying section details.

### Support beam size chart

Removable support beam size	Max pit clear opening length (L)	Beam wallbox dimensions		
		V	W	X
152 x 152 x 37kg/m UC	2000	238	260	300
203 x 152 x 52kg/m RSJ	2750	279	305	345
305 x 165 x 54kg/m UB	3900	387	410	450

Note: Removable support beams are supplied by Gatic

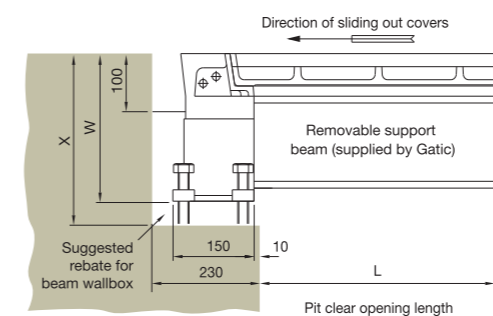

Section C - C

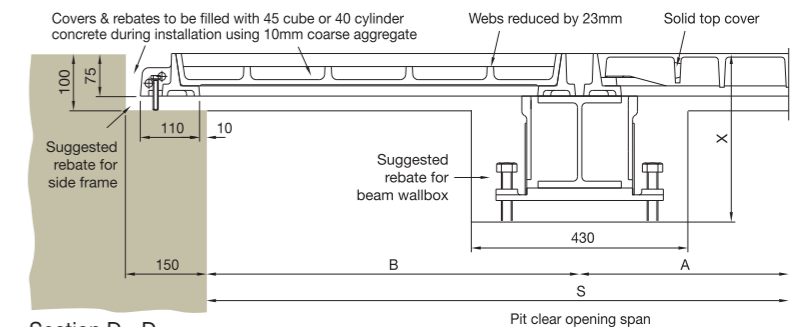

Section D - D



# GATIC Loading Group C250

## Introduction

This section includes Gatic covers and frames designed for LXading GrXup C270.

5 tonne wheel load, test load 250kN – Suitable for:

- Minor residential roads
- Cul-de-sacs
- Pedestrian precincts
- Yards etc



C270 assemblies are available with a choice of cover designs – recessed or solid top.

### Recessed for concrete infill

Recessed covers are available in a choice of designs designated by a 'Type' reference. C270 recessed covers are available as Type DLF, DMB, DM/F and DMR. Section drawings of the different recessed cover types are shown in the following pages.

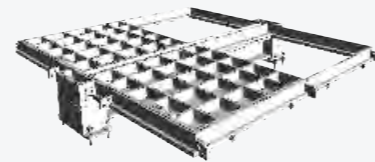

### Solid top

Solid top cover types are lighter in weight than recessed covers and feature a figured anti-slip surface. Solid top covers are denoted by the code Type DLS and DMS depicted in section in the following pages.

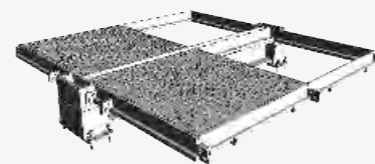

## Cover types

Single covers and frames



Duct covers and frames



Continuous trench covers and frames



Multispan covers and frames



If you are uncertain as to the adequacy of covers concerning a particular loading we recommend specifying covers in a higher loading group. For example if in doubt about covers in LXading GrXup C270 we recommend you specify covers in LXading GrXup D400.

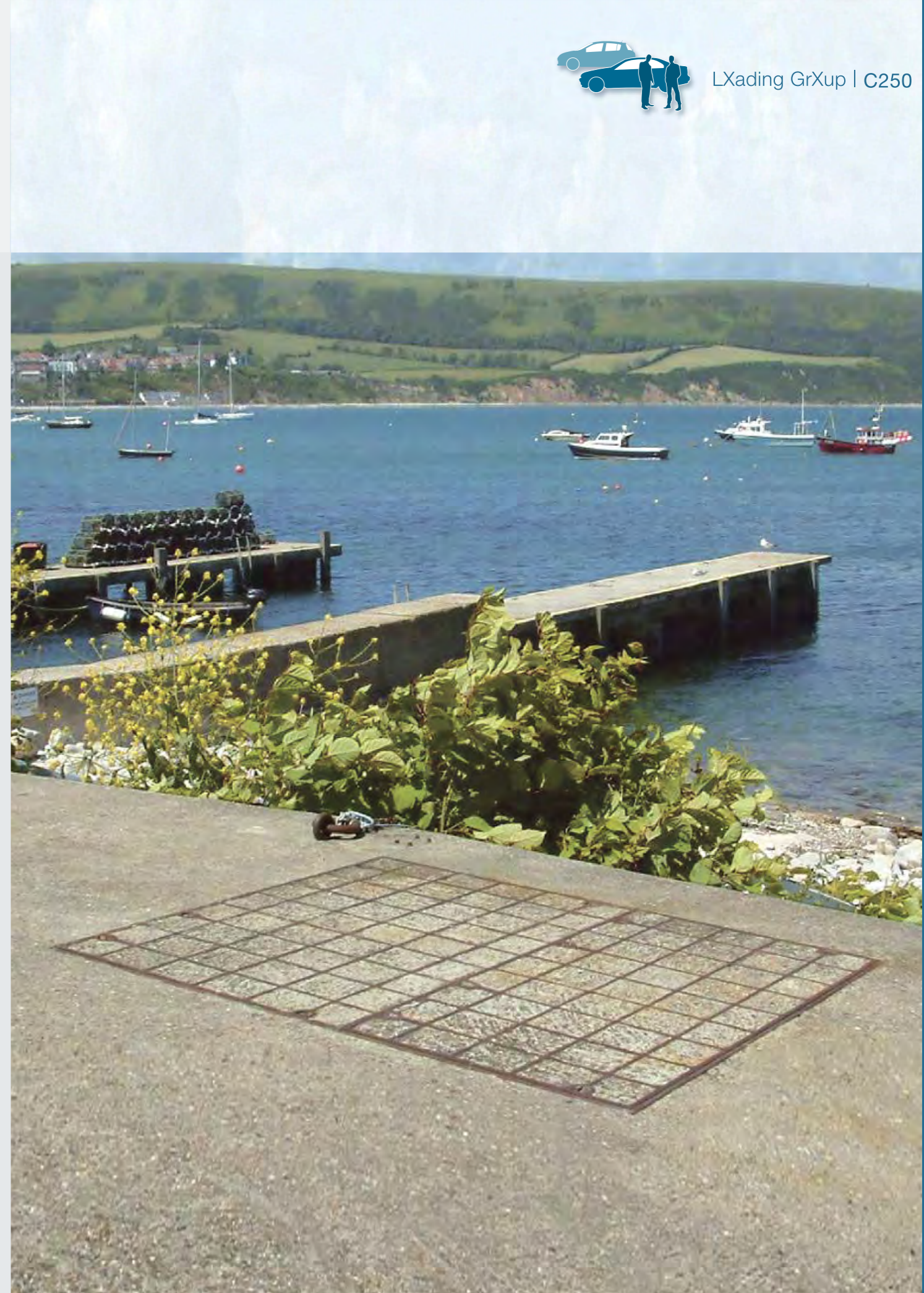



# GATIC

## Single recessed covers and frames



Covers recessed for concrete infill

Cover types: DLF, DMR, DM

To specify state:

1. Loading group
2. Pit clear opening size length (L) x span (S)
3. Cover type

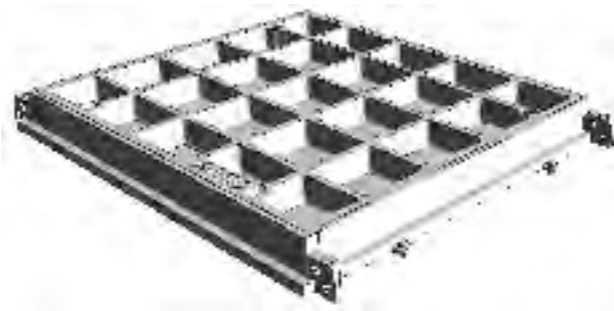

Pit clear opening sizes L x S	Cover type	Overall frame size length x width x depth	Suggested rebate size length x width x depth
750 x 300	DLF	900 x 540 x 75	1050 x 600 x 100
600 x 450	DLF	750 x 690 x 75	900 x 750 x 100
750 x 450	DMR	900 x 670 x 140	1150 x 850 x 165
600 x 600	DLF	770 x 840 x 75	900 x 900 x 100
750 x 600	DLF	920 x 840 x 75	1050 x 900 x 100
900 x 600	DLF	1070 x 840 x 75	1200 x 900 x 100
750 x 750	DLF	920 x 990 x 75	1050 x 1050 x 100
900 x 750	DLF	1070 x 990 x 75	1200 x 1050 x 100
900 x 900	DLF	1120 x 1140 x 75	1200 x 1200 x 100
600 x 1050	DM	820 x 1270 x 140	1000 x 1450 x 165
750 x 1050	DM	970 x 1270 x 140	1150 x 1450 x 165
1000 x 1050	DM	1220 x 1270 x 140	1400 x 1450 x 165
600 x 1200	DM	820 x 1420 x 140	1000 x 1600 x 165
750 x 1200	DM	970 x 1420 x 140	1150 x 1600 x 165

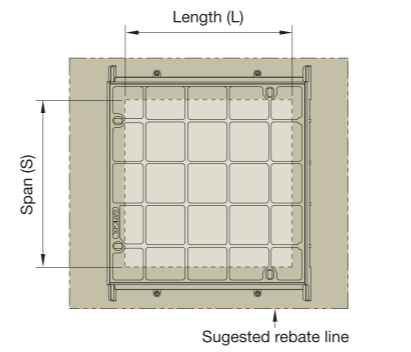

Plan of recessed single cover

## Single solid top covers and frames



Covers with solid top

Cover types: DLS, DMS

To specify state:

1. Loading group
2. Pit clear opening size length (L) x span (S)
3. Cover type



Pit clear opening sizes L x S	Cover type	Overall frame size length x width x depth	Suggested rebate size length x width x depth
600 x 600	DLS	770 x 840 x 75	900 x 900 x 100
750 x 600	DLS	920 x 840 x 75	1050 x 900 x 100
900 x 600	DLS	1070 x 840 x 75	1200 x 900 x 100
750 x 750	DLS	920 x 990 x 75	1050 x 1050 x 100
900 x 750	DLS	1070 x 990 x 75	1200 x 1050 x 100
900 x 900	DLS	1120 x 1040 x 75	1200 x 1200 x 100
600 x 1200	DMS	750 x 1420 x 140	1000 x 1600 x 165
750 x 1200	DMS	900 x 1420 x 140	1150 x 1600 x 165
1000 x 1000	DMS	1220 x 1220 x 140	1400 x 1400 x 165

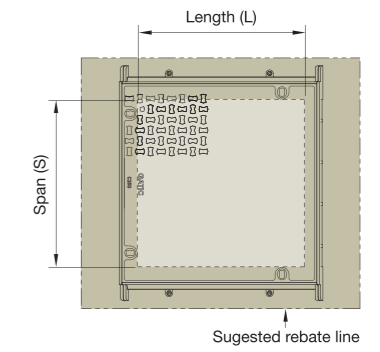

Plan of solid top single cover

### Cover types

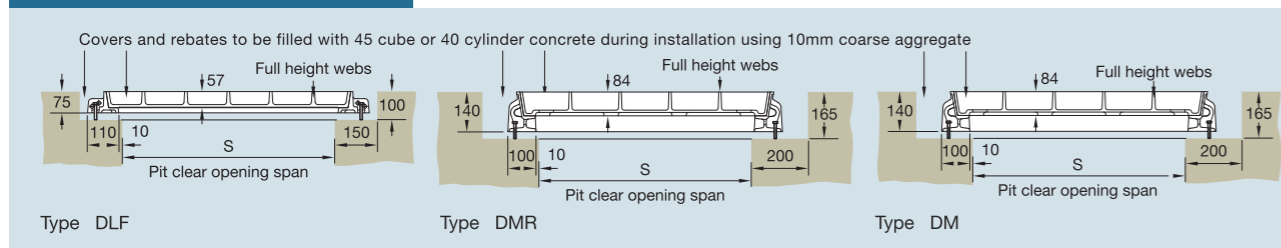

### Cover types

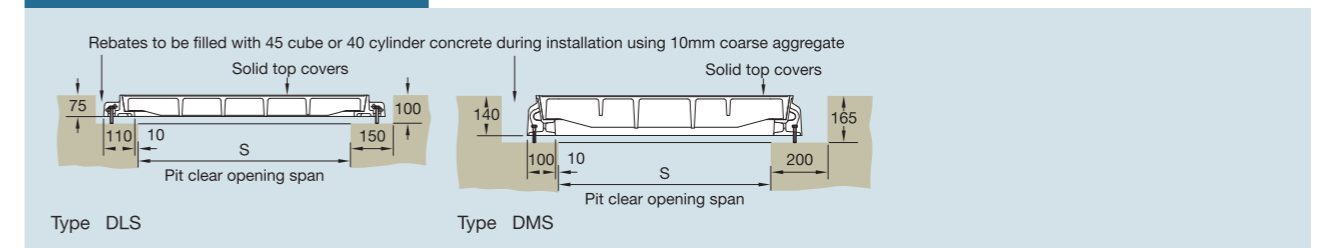





# GATIC

## Recessed duct covers and frames



Covers recessed for concrete infill

Cover types: DLF, DM

To specify state:

1. Loading group
2. Pit clear opening size length (L) x span (S)
3. Cover type

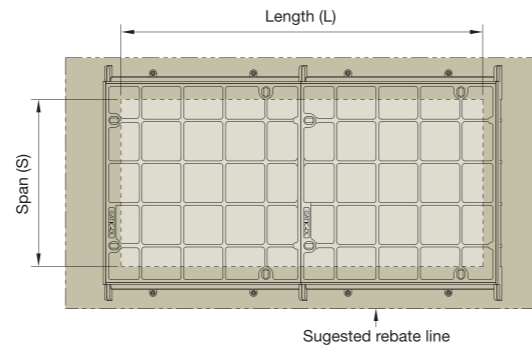

Plan of recessed duct cover

Pit clear opening sizes	Cover type	Suggested rebate size length x width x depth
300	DLF	(L + 300) x 600 x 100
450	DLF	(L + 300) x 750 x 100
600	DLF	(L + 300) x 900 x 100
750	DLF	(L + 300) x 1050 x 100
900	DLF	(L + 300) x 1200 x 100
1050	DM	(L + 400) x 1450 x 165
1200	DM	(L + 400) x 1600 x 165
1350	DM/F	Refer to our technical department
1500	DM/F	Refer to our technical department

Pit clear opening span (S)	Cover type	Standard pit clear opening length (L)											
		1300	1450	1600	1750	1900	2000	2150	2300	2450	2600	2700	2750
300	DLF	*	*	2	*	*	*	*	*	3	*	*	*
450	DLF	2	*	*	*	*	3	*	*	*	*	4	*
600	DLF	2	2	2	2	2	3	3	3	3	3	4	3
750	DLF	2	2	2	2	2	3	3	3	3	3	4	3
900	DLF	2	2	2	2	2	3	3	3	3	3	4	3
1050	DM	2	2	2	*	*	3	3	3	3	*	4	*
1200	DM	2	2	2	*	*	3	3	3	3	*	4	*

Pit clear opening span (S)	Cover type	Standard pit clear opening length (L)											
		2850	2900	3000	3150	3300	3400	3550	3700	3850	3900	4000	4150
300	DLF	*	*	*	*	4	*	*	*	*	*	*	5
450	DLF	*	*	*	*	*	5	*	*	*	*	*	*
600	DLF	4	3	4	4	4	5	5	5	5	4	5	5
750	DLF	4	3	4	4	4	5	5	5	5	4	5	5
900	DLF	4	3	4	4	4	5	5	5	5	4	5	5
1050	DM	4	*	4	4	4	5	5	5	5	*	5	5
1200	DM	4	*	4	4	4	5	5	5	5	*	5	5

\* Indicates standard sizes not available. The number shown indicates the quantity of cover parts. Other standard sizes may be available, refer to our technical department.

### Cover types

Covers and rebates to be filled with 45 cube or 40 cylinder concrete during installation using 10mm coarse aggregate

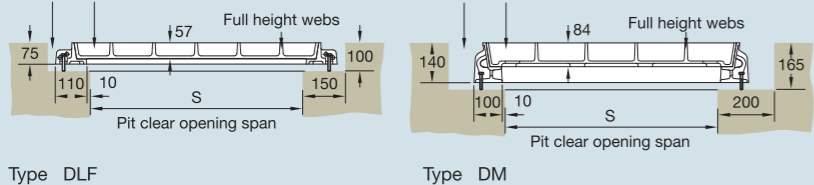

Type DLF

Type DM

## Solid top duct covers and frames



Covers with solid top

Cover types: DLS, DMS

To specify state:

1. Loading group
2. Pit clear opening size length (L) x span (S)
3. Cover type

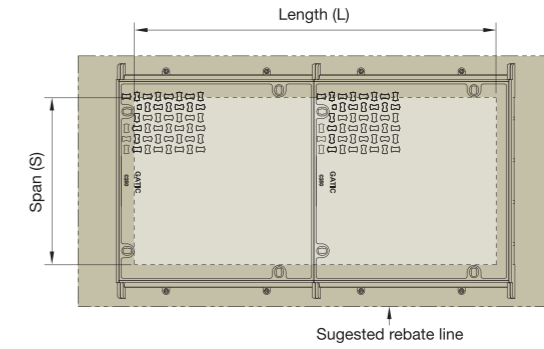

Plan of solid top duct cover

Pit clear opening sizes	Cover type	Suggested rebate size length x width x depth
600	DLS	(L + 300) x 900 x 100
750	DLS	(L + 300) x 1050 x 100
900	DLS	(L + 300) x 1200 x 100
1200	DMS	(L + 400) x 1600 x 165

Pit clear opening span (S)	Cover type	Standard pit clear opening length (L)											
		1300	1450	1600	1750	1900	2000	2150	2300	2450	2600	2700	2750
600	DLS	2	2	2	2	2	3	3	3	3	3	4	3
750	DLS	2	2	2	2	2	3	3	3	3	3	4	3
900	DLS	2	2	2	2	2	3	3	3	3	3	4	3
1200	DMS	2	2	2	*	*	3	3	3	3	*	4	*

Pit clear opening span (S)	Cover type	Standard pit clear opening length (L)											
		2850	2900	3000	3150	3300	3400	3550	3700	3850	3900	4000	4150
600	DLS	4	3	4	4	4	5	5	5	5	4	5	5
750	DLS	4	3	4	4	4	5	5	5	5	4	5	5
900	DLS	4	3	4	4	4	5	5	5	5	4	5	5
1200	DMS	4	*	4	4	4	5	5	5	5	*	5	5

\* Indicates standard sizes not available. The number shown indicates the quantity of cover parts. Other standard sizes may be available, refer to our technical department.

### Cover types

Rebates to be filled with 45 cube or 40 cylinder concrete during installation using 10mm coarse aggregate

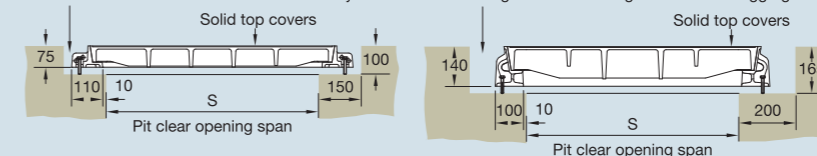

Type DLS

Type DMS



# GATIC

## Continuous recessed trench covers and frames



Covers recessed for concrete infill

Cover type DLF, DM

To specify state:

1. Loading group
2. Cover type
3. Supply layout drawing of trenches

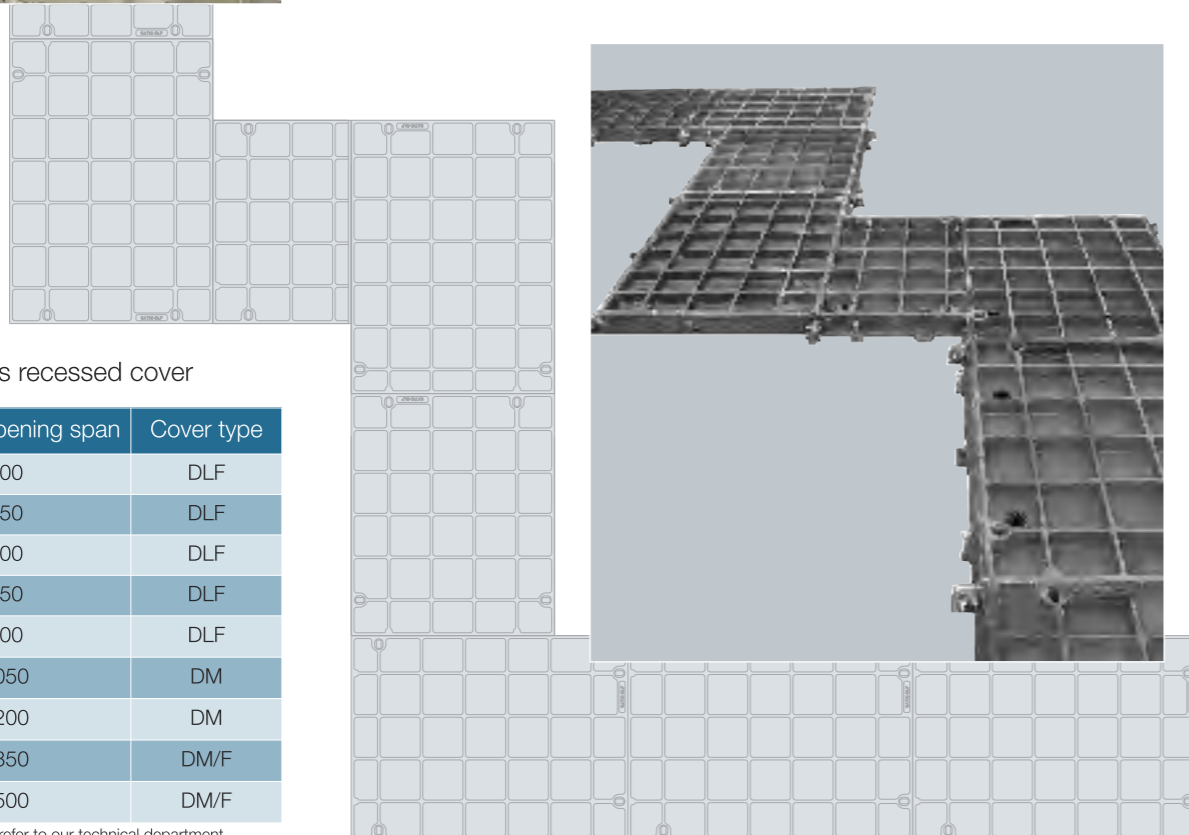
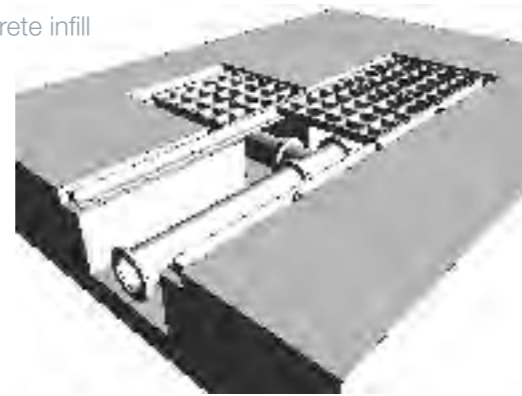

Continuous recessed cover

Pit clear opening span	Cover type
300	DLF
450	DLF
600	DLF
750	DLF
900	DLF
1050	DM
1200	DM
1350	DM/F
1500	DM/F

Note: type DM/F refer to our technical department

Gatic covers can be formed to make continuous trenches or layouts providing total access to services below.

Construction drawings are required so that Gatic cover layout drawings can be prepared.

### Cover types

Covers and rebates to be filled with 45 cube or 40 cylinder concrete during installation using 10mm coarse aggregate

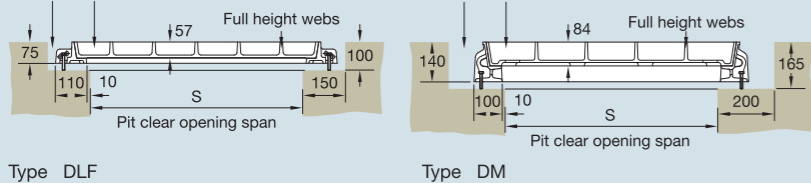

## Continuous solid top trench covers and frames

Covers with solid top

Cover type DLS, DMS

To specify state:

1. Loading group
2. Cover type
3. Supply layout drawing of trenches

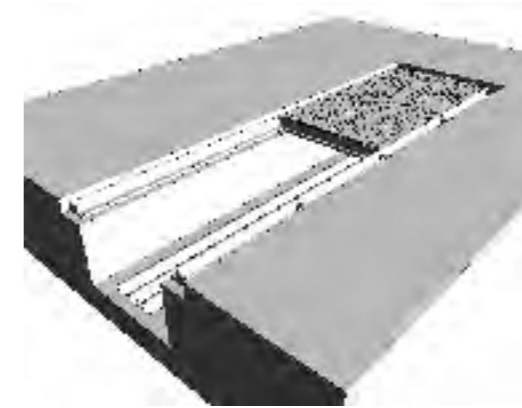

Continuous solid top cover

Pit clear opening span	Cover type
600	DLS
750	DLS
900	DLS
1200	DMS

Standard solid top covers are supplied in straight runs. Junctions and splays can be achieved by the inclusion of localised recessed covers. Refer to our technical department for more information.

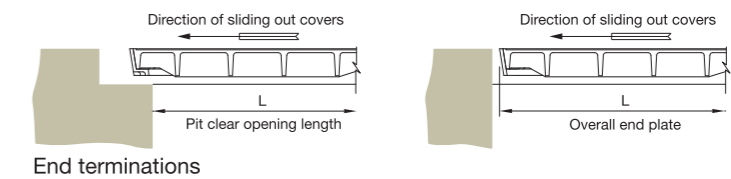

### Cover types

Rebates to be filled with 45 cube or 40 cylinder concrete during installation using 10mm coarse aggregate

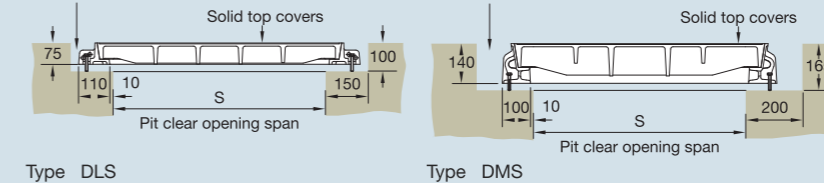



# GATIC

## Multispan covers and frames

### Specification

Below is sample specification information and notes for Multispan recessed covers and frames.

For more details on features and benefits of Gatic covers, see pages 14 to 15.

**Loading group Gatic C250**  
 5 tonne wheel load – test load 250 kN.

**Materials**  
 Ductile iron components to BS EN 1563:1997.  
 Structural steel removable beams to BS 4-1:2005.

**Finishes**  
 Units coated with black bituminous solution for protection during transit.  
 Removable supporting steelwork galvanised to BS EN ISO 1461:2009.

**Infill and surround concrete by customer**  
 Concrete strength, using 10mm coarse aggregate, to be:  
 45N/mm<sup>2</sup> for a test cube of 150mm or  
 40N/mm<sup>2</sup> for a test cylinder of 150mm diameter x 300mm high.

**Installation**  
 In accordance with instructions supplied by Gatic.

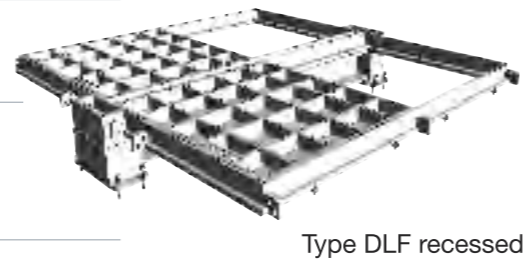

Type DLF recessed



Type DLS solid top

To specify use size and description format as follows:

**Gatic Multispan Recessed covers and frames** Cover type **DLF recessed**  
 Multiple access covers recessed for concrete infill with removable beams.

.... in no. .... (length) x .... (span) mm pit clear opening multi span cover and frame.  
 Gatic Type DLF Ductile Iron Recessed Cover in .... parts complete with  
 .... in no. .... x .... mm galvanised removable support beam spanning the .... (length) mm way.  
 Suitable for Loading Group C250 – Medium Duty 5 Tonnes Wheel Load (pneumatic tyre).

**Gatic Multispan Solid Top covers and frames** Cover type **DLS solid top**  
 Multiple solid top access covers with removable beams.

.... in no. .... (length) x .... (span) mm pit clear opening multi span cover and frame.  
 Gatic Type DLS Ductile Iron Solid Top Cover in .... parts complete with  
 .... in no. .... x .... mm galvanised removable support beam spanning the .... (length) mm way.  
 Suitable for Loading Group C250 – Medium Duty 5 Tonnes Wheel Load (pneumatic tyre).

Standard pit clear opening sizes are shown on Page 37.

Beam sizes and other dimensions are shown on Pages 38 and 39.

## Multispan covers and frames

### Product Selection

Refer to the table to identify which cover and beam configuration you require against pit clear opening length (L) and pit clear opening span (S). All dimensions are in millimetres.

		Pit clear opening length (L) mm												Beam centres mm													
		2 parts					3 parts				4 parts			A	B	C	D	E									
		1300	1450	1600	1750	1900	2000	2150	2300	2450	2600	2750	2900	2700	2850	3000	3150	3300	3450	3600	3750	3900					
2 parts	1 beam	1380	1530	1680	1830	1980	[Diagram: 2 parts, 1 beam]					[Diagram: 2 parts, 1 beam]			[Diagram: 2 parts, 1 beam]					690	690						
	2 beams	2160	2310	2460	2610	2760	[Diagram: 2 parts, 2 beams]					[Diagram: 2 parts, 2 beams]			[Diagram: 2 parts, 2 beams]					690	780	690					
	3 beams	2940	3090	3240	3390	3540	[Diagram: 2 parts, 3 beams]					[Diagram: 2 parts, 3 beams]			[Diagram: 2 parts, 3 beams]					690	780	780	690				
	4 beams	3720	3870	4020	4170	4320	[Diagram: 2 parts, 4 beams]					[Diagram: 2 parts, 4 beams]			[Diagram: 2 parts, 4 beams]					690	780	780	780	690			
	5 beams	4500	4650	4800	4950	5100	[Diagram: 2 parts, 5 beams]					[Diagram: 2 parts, 5 beams]			[Diagram: 2 parts, 5 beams]					690	780	930	780	690			
3 parts	1 beam	2000	2150	2300	2450	2600	[Diagram: 3 parts, 1 beam]				[Diagram: 3 parts, 1 beam]				[Diagram: 3 parts, 1 beam]				690	690							
	2 beams	2800	2950	3100	3250	3400	[Diagram: 3 parts, 2 beams]				[Diagram: 3 parts, 2 beams]				[Diagram: 3 parts, 2 beams]				690	780	690						
	3 beams	3600	3750	3900	4050	4200	[Diagram: 3 parts, 3 beams]				[Diagram: 3 parts, 3 beams]				[Diagram: 3 parts, 3 beams]				690	780	780	690					
	4 beams	4400	4550	4700	4850	5000	[Diagram: 3 parts, 4 beams]				[Diagram: 3 parts, 4 beams]				[Diagram: 3 parts, 4 beams]				690	780	780	840					
	5 beams	5200	5350	5500	5650	5800	[Diagram: 3 parts, 5 beams]				[Diagram: 3 parts, 5 beams]				[Diagram: 3 parts, 5 beams]				690	780	780	840	690				
4 parts	1 beam	2700	2850	3000	3150	3300	[Diagram: 4 parts, 1 beam]			[Diagram: 4 parts, 1 beam]			[Diagram: 4 parts, 1 beam]			[Diagram: 4 parts, 1 beam]					690	780	780	690			
	2 beams	3500	3650	3800	3950	4100	[Diagram: 4 parts, 2 beams]			[Diagram: 4 parts, 2 beams]			[Diagram: 4 parts, 2 beams]			[Diagram: 4 parts, 2 beams]					690	780	780	840			
	3 beams	4300	4450	4600	4750	4900	[Diagram: 4 parts, 3 beams]			[Diagram: 4 parts, 3 beams]			[Diagram: 4 parts, 3 beams]			[Diagram: 4 parts, 3 beams]					690	780	780	840	690		
	4 beams	5100	5250	5400	5550	5700	[Diagram: 4 parts, 4 beams]			[Diagram: 4 parts, 4 beams]			[Diagram: 4 parts, 4 beams]			[Diagram: 4 parts, 4 beams]					690	780	780	840	690		
	5 beams	5900	6050	6200	6350	6500	[Diagram: 4 parts, 5 beams]			[Diagram: 4 parts, 5 beams]			[Diagram: 4 parts, 5 beams]			[Diagram: 4 parts, 5 beams]					690	780	780	840	690		

Note: For other pit clear opening sizes please refer to our technical department



# GATIC

## Multispan covers and frames

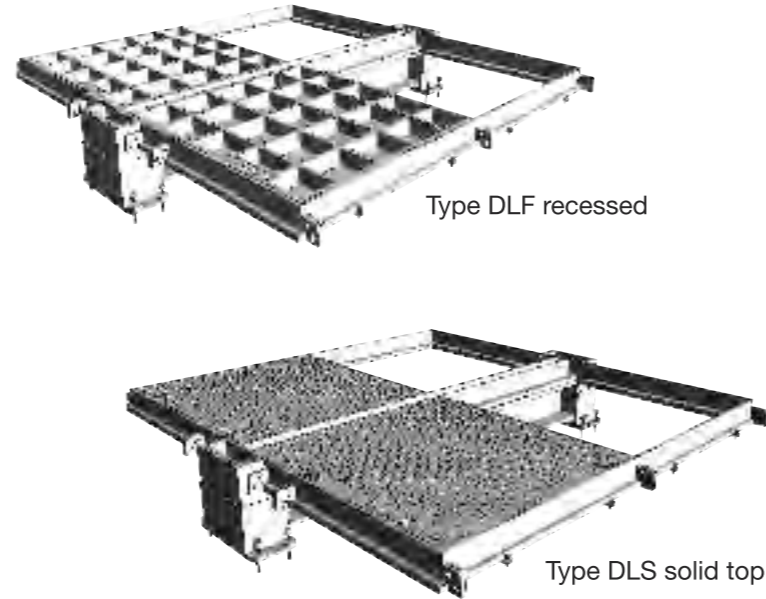

Covers recessed for concrete infill or solid top

Cover types: DLF (recessed)  
 DLS (solid top)

The details below show plan and sections of a typical recessed/solid top unit.

For selection and specification guidance, refer to pages 36, 37 and 39.

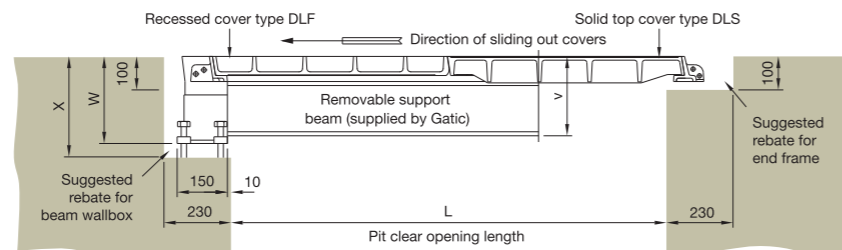

Section A - A

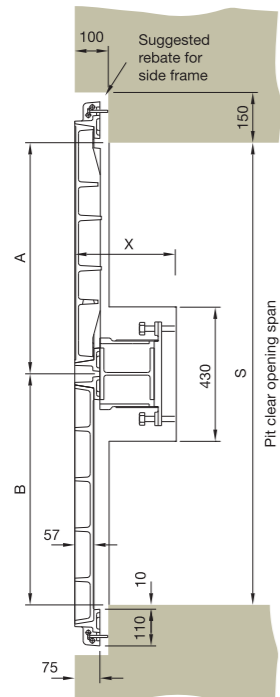

Section B - B

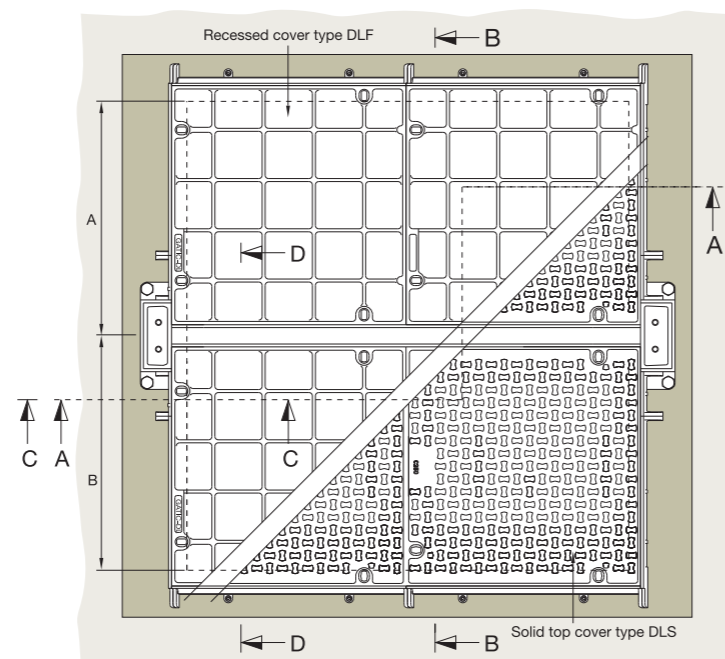

Plan showing recessed and solid top cover options

## Multispan covers and frames

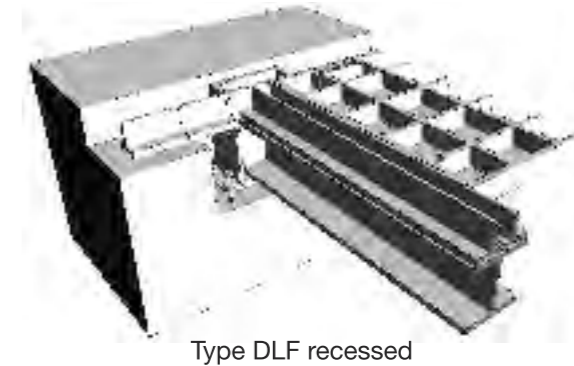

Type DLF recessed

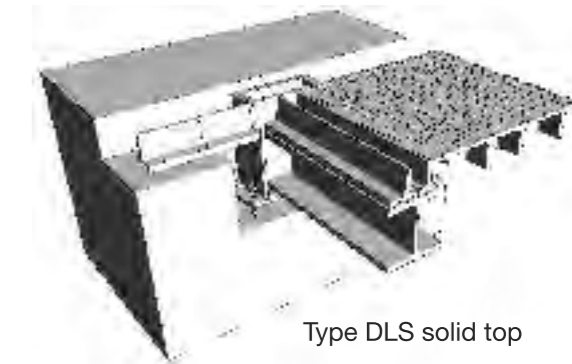

Type DLS solid top

### Beam Size

The required beam size for Multispan covers is dependent on the pit clear opening length and the loading group.

The table shows maximum beam length against beam size. The removable support beams are supplied by Gatic.

The table also indicates dimensions of the beam wallbox and rebate to suit different beam sizes. See also the accompanying section details.

### Support beam size chart

Removable support beam size	Max pit clear opening length (L)	Beam wallbox dimensions		
		V	W	X
152 x 152 x 37kg/m UC	1750	238	260	300
203 x 152 x 52kg/m RSJ	2300	279	305	345
305 x 165 x 54kg/m UB	3150	387	410	450
356 x 171 x 67kg/m UB	3900	440	465	505

Note: Removable support beams are supplied by Gatic

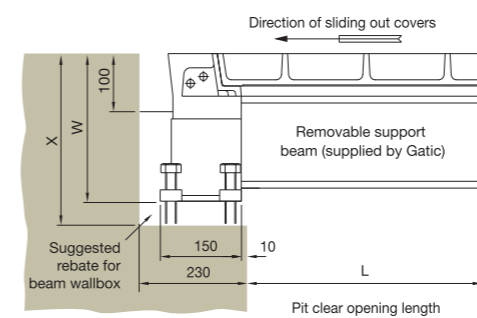

Section C - C

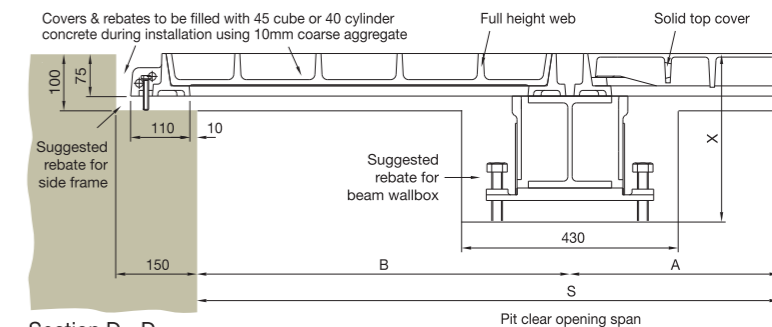

Section D - D



# GATIC Loading Group D400

## Introduction

This section includes Gatic covers and frames designed for Loading Group D400.

11.5 tonne wheel load,  
test load 400kN – Suitable for:

- Power stations
- Carriageways
- Hard shoulders
- Parking areas for all types of vehicles



D400 assemblies are available with a choice of cover designs – recessed or solid top.

### Recessed for concrete infill

Recessed covers are available in a choice of designs designated by a 'Type' reference. D400 recessed covers are available as Type DLF, DM, DM/F and DMR. Section drawings of the different recessed cover types are shown on the following pages.



### Solid top

Solid top cover types are lighter in weight than recessed covers, and feature a figured anti-slip surface. Solid top covers are denoted by the code Type DMS depicted in section on the following pages.



To prevent movement of covers in high traffic conditions, we recommend the use of a factory fitted vibration-resistant locking system. Can be fitted to recessed covers only. See page 14.

If you are uncertain as to the adequacy of covers conforming to a particular loading, we recommend specifying covers in a higher loading group. For example, if in doubt about covers in Loading Group D400, we recommend you specify covers in Loading Group E600.

## Cover types

### Single covers and frames



### Duct covers and frames



### Continuous trench covers and frames



### Multispan covers and frames





# GATIC

## Single recessed covers and frames



Covers recessed for concrete infill

Cover type: DLF, DMR, DM

To specify state:

1. Loading group
2. Pit clear opening size length (L) x span (S)
3. Cover type



Pit clear opening sizes L x S	Cover type	Overall frame size length x width x depth	Suggested rebate size length x width x depth
750 x 300	DLF	900 x 540 x 75	1050 x 600 x 100
600 x 450	DMR	750 x 670 x 140	1000 x 850 x 165
750 x 450	DMR	900 x 670 x 140	1150 x 850 x 165
600 x 600	DMR	750 x 820 x 140	1000 x 1000 x 165
750 x 600	DMR	900 x 820 x 140	1150 x 1000 x 165
900 x 600	DMR	1050 x 820 x 140	1300 x 1000 x 165
750 x 750	DMR	900 x 970 x 140	1150 x 1150 x 165
900 x 750	DMR	1050 x 970 x 140	1300 x 1150 x 165
900 x 900	DMR	1120 x 1120 x 140	1300 x 1300 x 165
600 x 1050	DM	820 x 1270 x 140	1000 x 1450 x 165
750 x 1050	DM	970 x 1270 x 140	1150 x 1450 x 165
1000 x 1050	DM	1220 x 1270 x 140	1400 x 1450 x 165
600 x 1200	DM	820 x 1420 x 140	1000 x 1600 x 165
750 x 1200	DM	970 x 1420 x 140	1150 x 1600 x 165

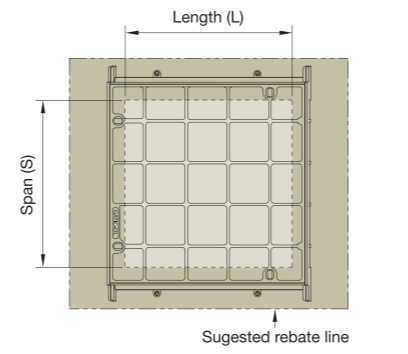

Plan of recessed single cover

## Single solid top covers and frames



Covers with solid top

Cover type DMS

To specify state:

1. Loading group
2. Pit clear opening size length (L) x span (S)
3. Cover type



Pit clear opening sizes L x S	Cover type	Overall frame size length x width x depth	Suggested rebate size length x width x depth
600 x 600	DMS	750 x 820 x 140	1000 x 1000 x 165
750 x 600	DMS	900 x 820 x 140	1150 x 1000 x 165
900 x 600	DMS	1050 x 820 x 140	1300 x 1000 x 165
750 x 750	DMS	900 x 970 x 140	1150 x 1150 x 165
900 x 750	DMS	1050 x 970 x 140	1300 x 1150 x 165
900 x 900	DMS	1120 x 1120 x 140	1300 x 1300 x 165
600 x 1200	DMS	820 x 1420 x 140	1000 x 1600 x 165
750 x 1200	DMS	970 x 1420 x 140	1150 x 1600 x 165
1000 x 1000	DMS	1220 x 1220 x 140	1400 x 1400 x 165

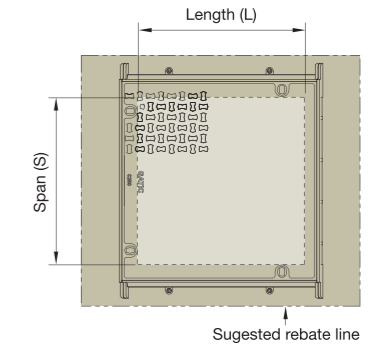

Plan of solid top single cover

For high density traffic conditions refer to page 14.

### Cover types

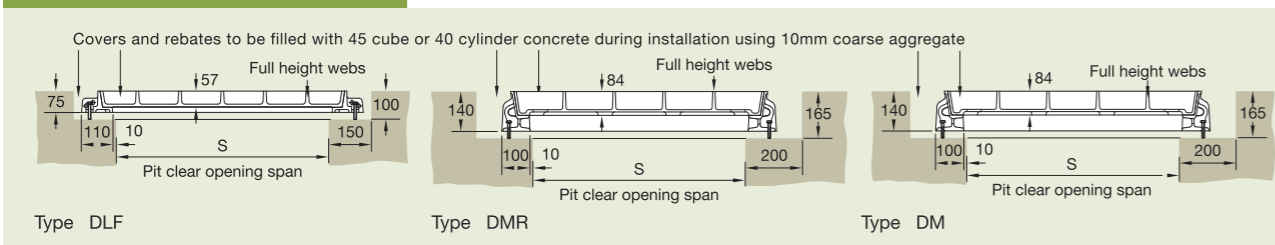

### Cover type

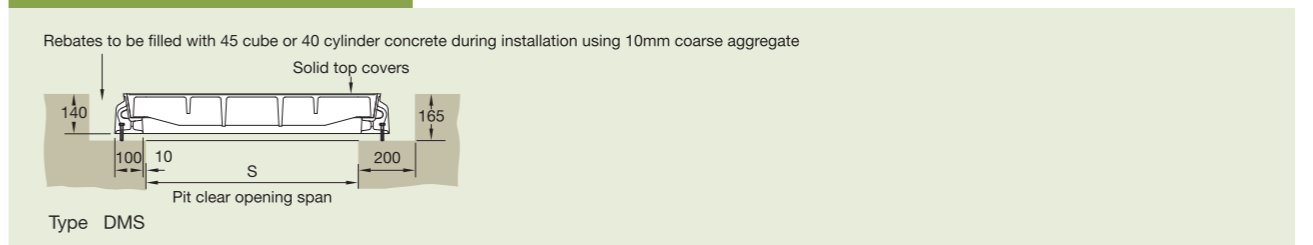



# GATIC

## Recessed duct covers and frames



Covers recessed for concrete infill

Cover type DLF, DMR, DM

To specify state:

1. Loading group
2. Pit clear opening size length (L) x span (S)
3. Cover type

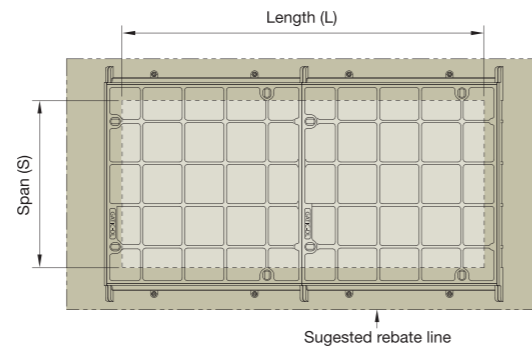

Plan of recessed duct cover

Pit clear opening sizes	Cover type	Suggested rebate size length x width x depth
300	DLF	(L + 300) x 600 x 100
450	DMR	(L + 400) x 850 x 165
600	DMR	(L + 400) x 1000 x 165
750	DMR	(L + 400) x 1150 x 165
900	DMR	(L + 400) x 1300 x 165
1050	DM	(L + 400) x 1450 x 165
1200	DM	(L + 400) x 1600 x 165
1350	DM/F	Refer to our technical department
1500	DM/F	Refer to our technical department

Pit clear opening span (S)	Cover type	Standard pit clear opening length (L)											
		1300	1450	1600	1750	1900	2000	2150	2300	2450	2600	2700	2750
300	DLF	*	*	2	*	*	*	*	*	3	*	*	*
450	DMR	2	2	2	*	*	3	3	3	3	*	4	*
600	DMR	2	2	2	2	2	3	3	3	3	3	4	3
750	DMR	2	2	2	2	2	3	3	3	3	3	4	3
900	DMR	2	2	2	2	2	3	3	3	3	3	4	3
1050	DM	2	2	2	*	*	3	3	3	3	*	4	*
1200	DM	2	2	2	*	*	3	3	3	3	*	4	*

Pit clear opening span (S)	Cover type	Standard pit clear opening length (L)											
		2850	2900	3000	3150	3300	3400	3550	3700	3850	3900	4000	4150
300	DLF	*	*	*	*	4	*	*	*	*	*	*	5
450	DMR	4	*	4	4	4	5	5	5	5	*	5	5
600	DMR	4	3	4	4	4	5	5	5	5	4	5	5
750	DMR	4	3	4	4	4	5	5	5	5	4	5	5
900	DMR	4	3	4	4	4	5	5	5	5	4	5	5
1050	DM	4	*	4	4	4	5	5	5	5	*	5	5
1200	DM	4	*	4	4	4	5	5	5	5	*	5	5

\* Indicates standard sizes not available. The number shown indicates the quantity of cover parts. Other standard sizes may be available, refer to our technical department.

### Cover types

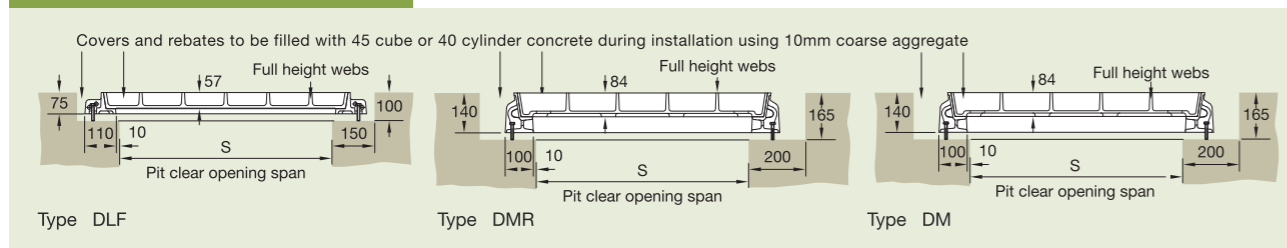

## Solid top duct covers and frames



Covers with solid top

Cover type DMS

To specify state:

1. Loading group
2. Pit clear opening size length (L) x span (S)
3. Cover type

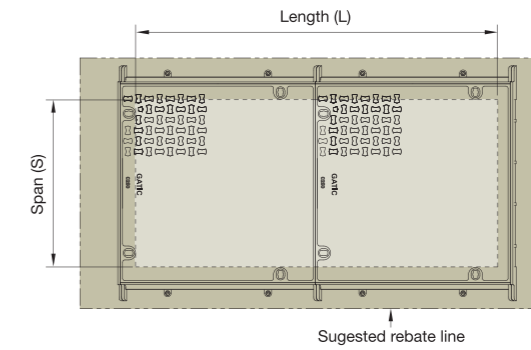

Plan of solid top duct cover

Pit clear opening sizes	Cover type	Suggested rebate size length x width x depth
600	DMS	(L + 400) x 1000 x 165
750	DMS	(L + 400) x 1150 x 165
900	DMS	(L + 400) x 1300 x 165
1200	DMS	(L + 400) x 1600 x 165

For high density traffic conditions refer to page 14.

Pit clear opening span (S)	Cover type	Standard pit clear opening length (L)											
		1300	1450	1600	1750	1900	2000	2150	2300	2450	2600	2700	2750
600	DMS	2	2	2	2	2	3	3	3	3	3	4	3
750	DMS	2	2	2	2	2	3	3	3	3	3	4	3
900	DMS	2	2	2	2	2	3	3	3	3	3	4	3
1200	DMS	2	2	2	*	*	3	3	3	3	*	4	*

Pit clear opening span (S)	Cover type	Standard pit clear opening length (L)											
		2850	2900	3000	3150	3300	3400	3550	3700	3850	3900	4000	4150
600	DMS	4	3	4	4	4	5	5	5	5	4	5	5
750	DMS	4	3	4	4	4	5	5	5	5	4	5	5
900	DMS	4	3	4	4	4	5	5	5	5	4	5	5
1200	DMS	4	*	4	4	4	5	5	5	5	*	5	5

\* Indicates standard sizes not available. The number shown indicates the quantity of cover parts. Other standard sizes may be available, refer to our technical department.

### Cover type

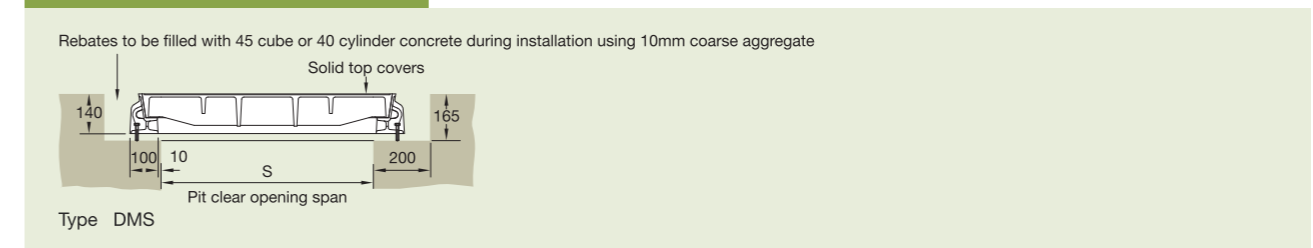



# GATIC

## Continuous recessed trench covers and frames



Covers recessed for concrete infill

Cover types: DLF, DM, DM/F

To specify state:

1. Loading group
2. Cover type
3. Supply layout drawing of trenches

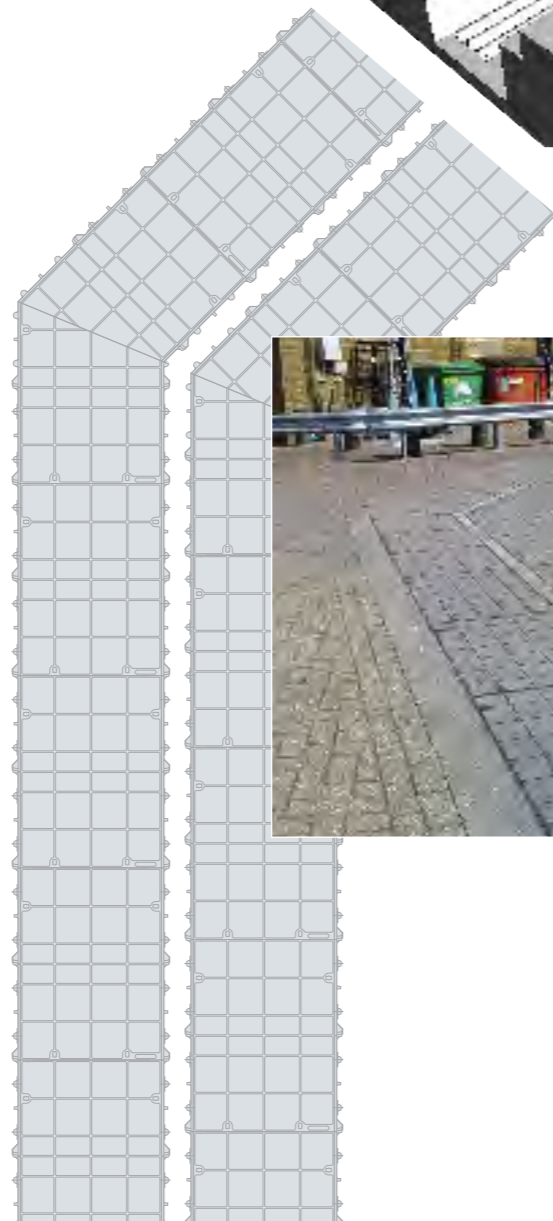
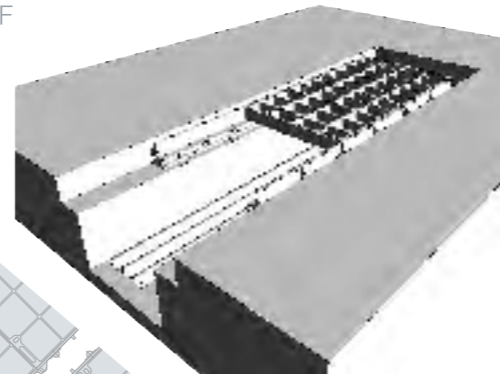

### Continuous recessed cover

Pit clear opening span	Cover type
300	DLF
450	DMR
600	DMR
750	DMR
900	DMR
1050	DM
1200	DM
1350	DM/F
1500	DM/F

\* For type DM/F refer to our technical department

Gatic covers can be formed to make continuous trenches or layouts providing total access to services below.

Construction drawings are required so that Gatic cover layout drawings can be prepared.



### Cover types

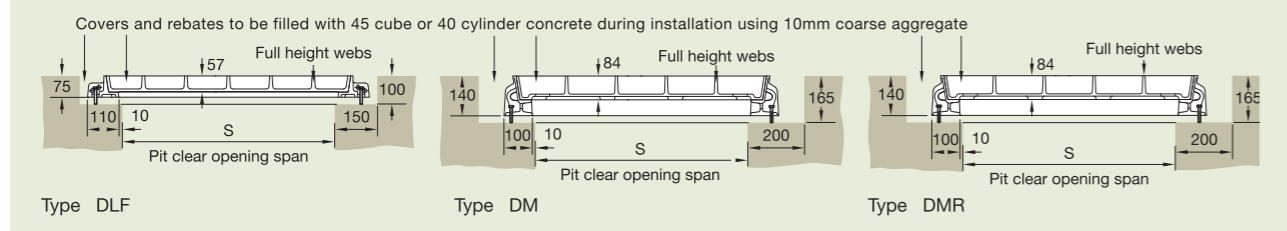

## Continuous solid top trench covers and frames



Covers with solid top

Cover types: DMS

To specify state:

1. Loading group
2. Cover type
3. Supply layout drawing of trenches

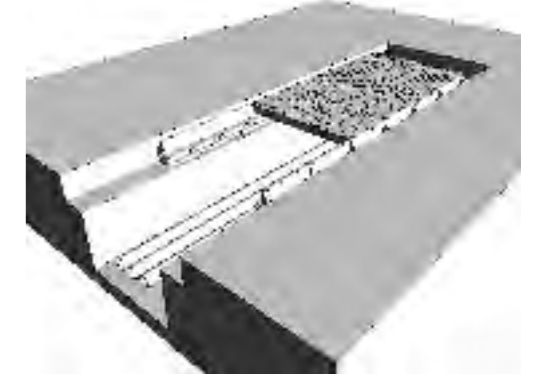

### Continuous solid top cover

Pit clear opening span	Cover type
600	DMS
750	DMS
900	DMS
1200	DMS

For high density traffic conditions refer to page 14.



Standard solid top covers are supplied in straight runs. Junctions and splays can be achieved by the inclusion of localised recessed covers. Refer to our technical department for more information.

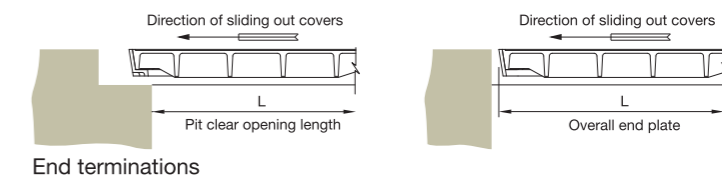

### Cover type

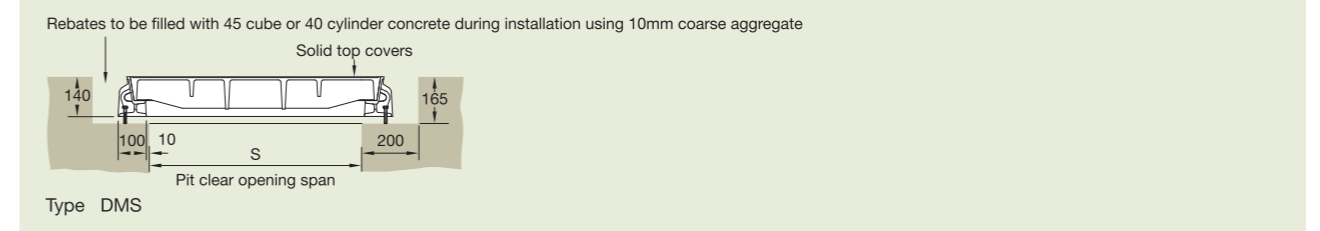





# GATIC

## Multispan covers and frames

### Specification

Below is sample specification information and notes for Multispan recessed covers and frames.

For more details on features and benefits of Gatic covers, see pages 14 to 15.

#### Loading group Gatic D400

11.5 tonne wheel load – test load 400 kN.

#### Materials

Ductile iron components to BS EN 1563:1997.

Structural steel removable beams to BS 4-1:2005.

#### Finishes

Units coated with black bituminous solution for protection during transit.

Removable supporting steelwork galvanised to BS EN ISO 1461:2009.

#### Infill and surround concrete by customer

Concrete strength, using 10mm coarse aggregate, to be:

45N/mm<sup>2</sup> for a test cube of 150mm or

40N/mm<sup>2</sup> for a test cylinder of 150mm diameter x 300mm high.

#### Installation

In accordance with instructions supplied by Gatic.



Type DMR recessed

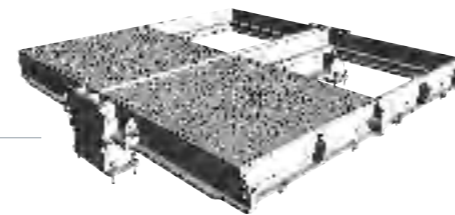

Type DMS solid top

To specify use size and description format as follows:

#### Gatic Multispan Recessed covers and frames Cover type DMR recessed

Multiple access covers recessed for concrete infill with removable beams.

.... in no. .... (length) x .... (span) mm pit clear opening multi span cover and frame.

Gatic Type DMR Ductile Iron Recessed Cover in .... parts complete with

.... in no. .... x .... mm galvanised removable support beam spanning the .... (length) mm way.

Suitable for Loading Group D400 – 11.5 Tonnes Wheel Load (pneumatic tyre).

#### Gatic Multispan Solid Top covers and frames Cover type DMS solid top

Multiple solid top access covers with removable beams.

.... in no. .... (length) x .... (span) mm pit clear opening multi span cover and frame.

Gatic Type DMS Ductile Iron Solid Top Cover in .... parts complete with

.... in no. .... x .... mm galvanised removable support beam spanning the .... (length) mm way.

Suitable for Loading Group D400 – 11.5 Tonnes Wheel Load (pneumatic tyre).

Standard pit clear opening sizes are shown on Page 49.

Beam sizes and other dimensions are shown on Pages 50 and 51.

For high density traffic conditions refer to page 14.

## Multispan covers and frames

### Product Selection

Refer to the table to identify which cover and beam configuration you require against pit clear opening length (L) and pit clear opening span (S). All dimensions are in millimetres.

Pit clear opening span (S) mm	Pit clear opening length (L) mm												Beam centres mm											
	2 parts			3 parts			4 parts						A	B	C	D	E							
	1300	1450	1600	1750	1900	2000	2150	2300	2450	2600	2750	2900	2700	2850	3000	3150	3300	3450	3600	3750	3900			
1380	[Diagram]			[Diagram]			[Diagram]						690	690										
1530	[Diagram]			[Diagram]			[Diagram]						840	690										
1680	[Diagram]			[Diagram]			[Diagram]						840	840										
1830	[Diagram]			[Diagram]			[Diagram]						990	840										
1980	[Diagram]			[Diagram]			[Diagram]						990	990										
2160	[Diagram]			[Diagram]			[Diagram]						690	780	690									
2310	[Diagram]			[Diagram]			[Diagram]						690	930	690									
2460	[Diagram]			[Diagram]			[Diagram]						840	780	840									
2610	[Diagram]			[Diagram]			[Diagram]						840	930	840									
2760	[Diagram]			[Diagram]			[Diagram]						840	1080	840									
2910	[Diagram]			[Diagram]			[Diagram]						990	930	990									
3060	[Diagram]			[Diagram]			[Diagram]						990	1080	990									
2940	[Diagram]			[Diagram]			[Diagram]						690	780	780	690								
3090	[Diagram]			[Diagram]			[Diagram]						840	780	780	690								
3240	[Diagram]			[Diagram]			[Diagram]						840	780	780	840								
3390	[Diagram]			[Diagram]			[Diagram]						840	930	930	690								
3540	[Diagram]			[Diagram]			[Diagram]						840	930	930	840								
3690	[Diagram]			[Diagram]			[Diagram]						990	930	930	840								
3840	[Diagram]			[Diagram]			[Diagram]						990	930	930	990								
3990	[Diagram]			[Diagram]			[Diagram]						990	1080	1080	840								
4140	[Diagram]			[Diagram]			[Diagram]						990	1080	1080	990								
3720	[Diagram]			[Diagram]			[Diagram]						690	780	780	780	690							
3870	[Diagram]			[Diagram]			[Diagram]						690	780	930	780	690							
4020	[Diagram]			[Diagram]			[Diagram]						840	780	780	780	840							
4170	[Diagram]			[Diagram]			[Diagram]						690	930	930	930	690							
4320	[Diagram]			[Diagram]			[Diagram]						840	930	780	930	840							
4470	[Diagram]			[Diagram]			[Diagram]						840	930	930	930	840							
4620	[Diagram]			[Diagram]			[Diagram]						840	930	1080	930	840							
4770	[Diagram]			[Diagram]			[Diagram]						990	930	930	930	990							
4920	[Diagram]			[Diagram]			[Diagram]						990	930	1080	930	990							
5070	[Diagram]			[Diagram]			[Diagram]						990	1080	930	1080	990							
5220	[Diagram]			[Diagram]			[Diagram]						990	1080	1080	1080	990							

Note: For other pit clear opening sizes please refer to our technical department



# GATIC

## Multispan covers and frames

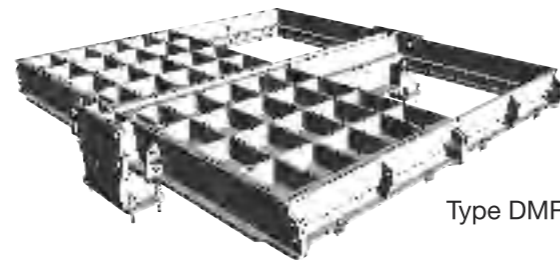

Type DMR recessed



Type DMS solid top

Covers recessed for concrete infill or solid top

Cover types: DMR (recessed)  
DMS (solid top)

The details below show plan and sections of a typical recessed/solid top unit.

For selection and specification guidance, refer to pages 48, 49 and 51.

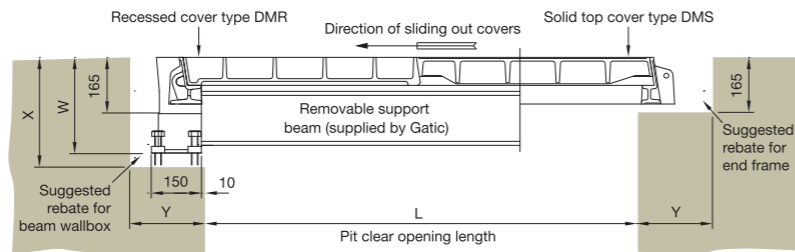

Section A - A

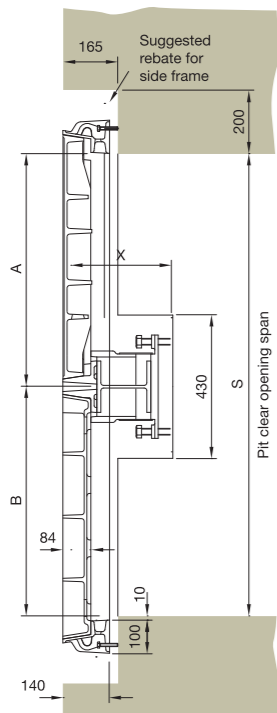

Section B - B

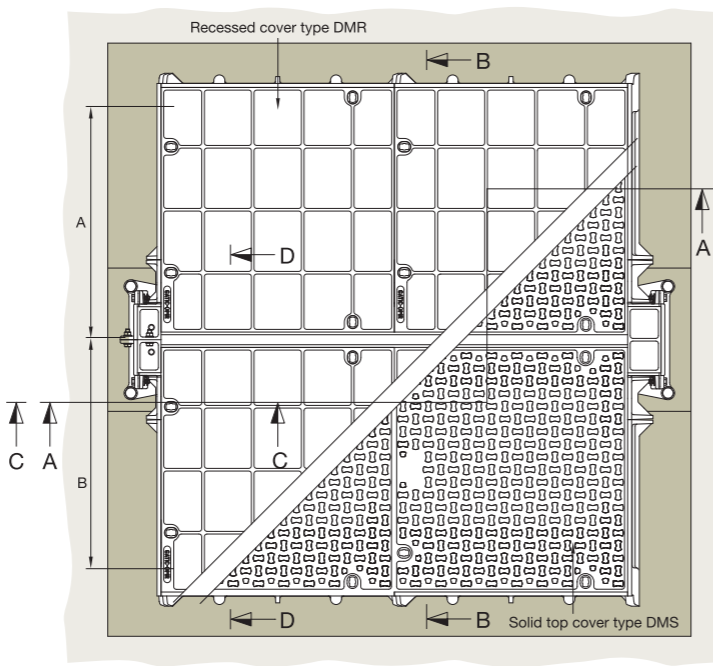

Plan showing recessed and solid top cover options

## Multispan covers and frames

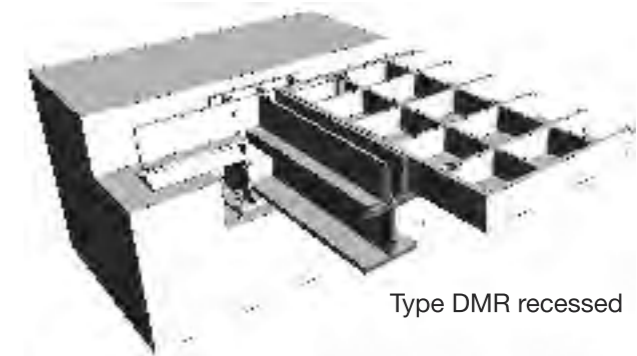

Type DMR recessed

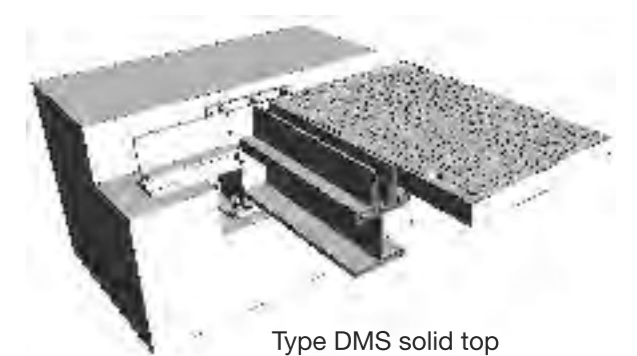

Type DMS solid top

### Beam Size

The required beam size for Multispan covers is dependent on the pit clear opening length and the loading group.

The table shows maximum beam length against beam size. The removable support beams are supplied by Gatic.

The table also indicates dimensions of the beam wallbox and rebate to suit different beam sizes. See also the accompanying section details.

### Support beam size chart

Removable support beam size	Max pit clear opening length (L)	Beam wallbox dimensions			
		V	W	X	Y
152 x 152 x 37kg/m UC	1300	265	290	330	230
203 x 152 x 52kg/m RSJ	1750	306	330	370	230
305 x 165 x 54kg/m UB	2300	414	440	480	230
356 x 171 x 67kg/m UB	2850	467	490	535	300
457 x 152 x 82kg/m UB	3450	568	595	635	300
533 x 210 x 122kg/m UB	3900	648	670	715	300

Note: Removable support beams are supplied by Gatic

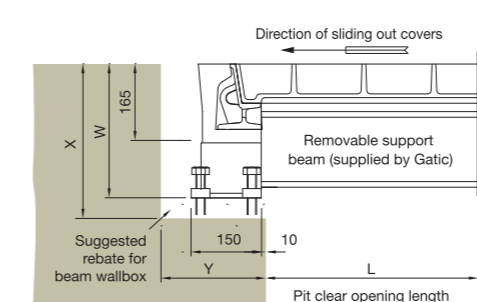

Section C - C

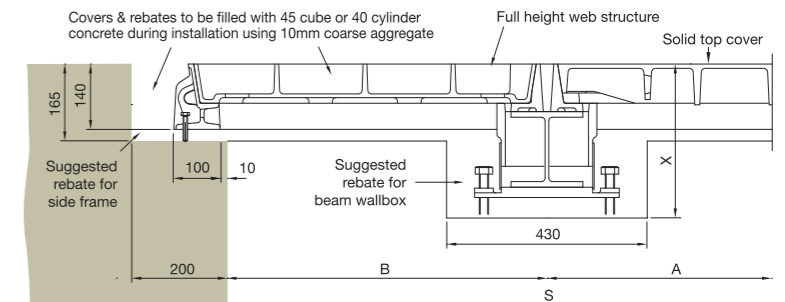

Section D - D



# GATIC Loading Group E600

## Introduction

This section includes Gatic covers and frames designed for Loading Group E600.

20 tonne wheel load,  
test load 600kN – Suitable for:

Some airfield pavements  
dockyards

Dockyards

Other areas where single slow moving wheel loads up to 20 tonne may be encountered

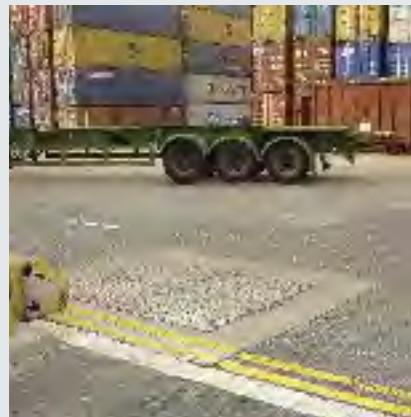

E600 assemblies are available with a choice of cover designs – recessed or solid top.

### Recessed for concrete infill

Recessed covers are available in a choice of designs designated by a 'Type' reference. E600 recessed covers are available as Type DLF, DM and DMR. Section drawings of the different recessed cover types are shown on the following pages.



### Solid top

Solid top cover types are lighter in weight than recessed covers, and feature a figured anti-slip surface. Solid top covers are denoted by the code Type DMS and STF depicted in section on the following pages.



To prevent movement of covers in high traffic conditions, we recommend the use of a factory fitted vibration-resistant locking system. Can be fitted to recessed covers only. See page 14.

If you are uncertain as to the adequacy of covers conforming to a particular loading, we recommend specifying covers in a higher loading group. For example, if in doubt about covers in Loading Group E600, we recommend you specify covers in Loading Group F900.

## Cover types

Single covers and frames



Continuous trench covers and frames



Duct covers and frames



Multispan covers and frames





# GATIC

## Single recessed covers and frames



Covers recessed for concrete infill

Cover type: DLF, DMR, DM

To specify state:

1. Loading group
2. Pit clear opening size length (L) x span (S)
3. Cover type



Pit clear opening sizes L x S	Cover type	Overall frame size length x width x depth	Suggested rebate size length x width x depth
750 x 300	DLF	900 x 540 x 75	1050 x 600 x 100
600 x 450	DMR	750 x 670 x 140	1000 x 850 x 165
750 x 450	DMR	900 x 670 x 140	1150 x 850 x 165
600 x 600	DMR	750 x 820 x 140	1000 x 1000 x 165
750 x 600	DMR	900 x 820 x 140	1150 x 1000 x 165
900 x 600	DMR	1050 x 820 x 140	1300 x 1000 x 165
750 x 750	DMR	900 x 970 x 140	1150 x 1150 x 165
900 x 750	DMR	1050 x 970 x 140	1300 x 1150 x 165
900 x 900	DMR	1120 x 1120 x 140	1300 x 1300 x 165
600 x 1050	DM	820 x 1270 x 140	1000 x 1450 x 165
750 x 1050	DM	970 x 1270 x 140	1150 x 1450 x 165
1000 x 1050	DM	1220 x 1270 x 140	1400 x 1450 x 165
600 x 1200	DM	820 x 1420 x 140	1000 x 1600 x 165
750 x 1200	DM	970 x 1420 x 140	1150 x 1600 x 165

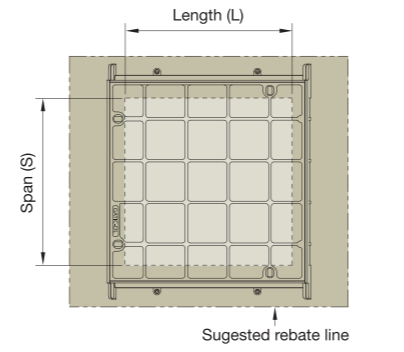

Plan of recessed single cover

## Single solid top covers and frames



Covers with solid top

Cover type STF, DMS

To specify state:

1. Loading group
2. Pit clear opening size length (L) x span (S)
3. Cover type



Pit clear opening sizes L x S	Cover type	Overall frame size length x width x depth	Suggested rebate size length x width x depth
600 x 600	STF	750 x 820 x 140	1000 x 1000 x 165
750 x 600	STF	900 x 820 x 140	1150 x 1000 x 165
900 x 600	STF	1050 x 820 x 140	1300 x 1000 x 165
700 x 700	STF	850 x 920 x 140	1100 x 1100 x 165
750 x 750	STF	900 x 970 x 140	1150 x 1150 x 165
900 x 750	STF	1050 x 970 x 140	1300 x 1150 x 165
900 x 900	STF	1120 x 1120 x 140	1300 x 1300 x 165
1000 x 1000	DMS	1220 x 1220 x 140	1400 x 1400 x 165

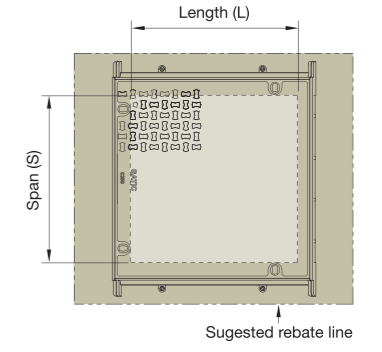

Plan of solid top single cover

For high density traffic conditions refer to page 14.

### Cover types

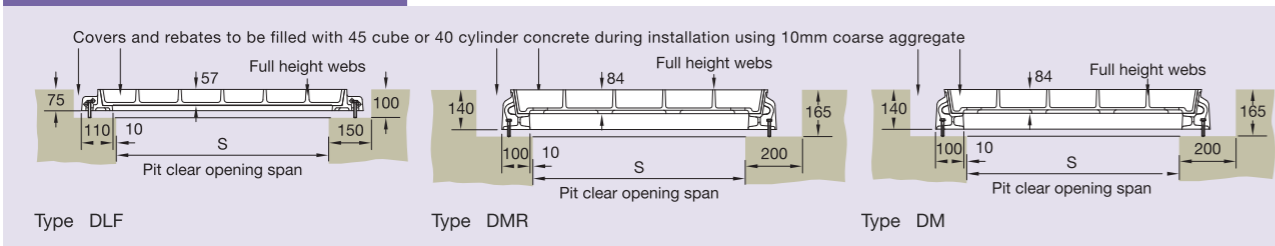

### Cover types

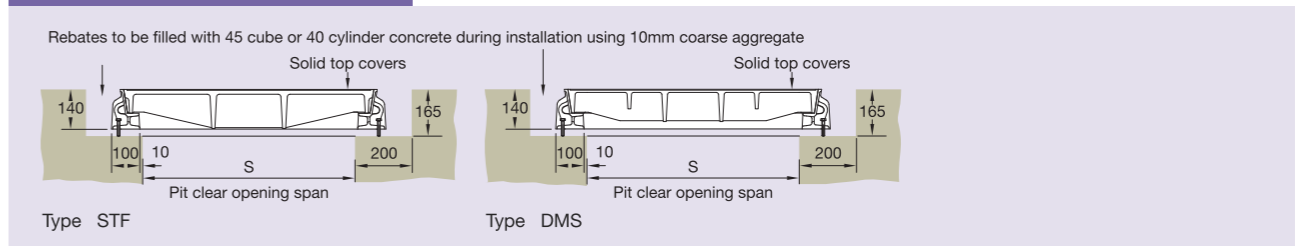



# GATIC

## Recessed duct covers and frames



Covers recessed for concrete infill

Cover type DLF, DMR, DM

To specify state:

1. Loading group
2. Pit clear opening size length (L) x span (S)
3. Cover type

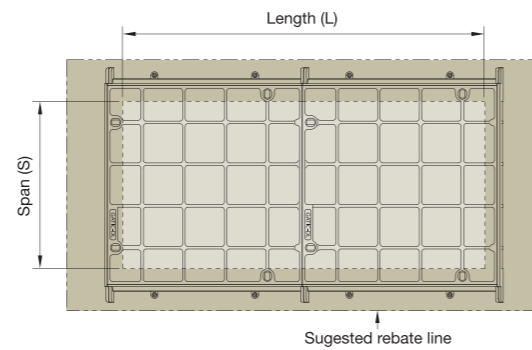

Plan of recessed duct cover

Pit clear opening sizes	Cover type	Suggested rebate size length x width x depth
300	DLF	(L + 300) x 600 x 100
450	DMR	(L + 400) x 850 x 165
600	DMR	(L + 400) x 1000 x 165
750	DMR	(L + 400) x 1150 x 165
900	DMR	(L + 400) x 1300 x 165
1050	DM	(L + 400) x 1450 x 165
1200	DM	(L + 400) x 1600 x 165
1350	DM/F	Refer to our technical department
1500	DM/F	Refer to our technical department

Pit clear opening span (S)	Cover type	Standard pit clear opening length (L)											
		1300	1450	1600	1750	1900	2000	2150	2300	2450	2600	2700	2750
300	DLF	*	*	2	*	*	*	*	*	3	*	*	*
450	DMR	2	2	2	*	*	3	3	3	3	*	4	*
600	DMR	2	2	2	2	2	3	3	3	3	3	4	3
750	DMR	2	2	2	2	2	3	3	3	3	3	4	3
900	DMR	2	2	2	2	2	3	3	3	3	3	4	3
1050	DM	2	2	2	*	*	3	3	3	3	*	4	*
1200	DM	2	2	2	*	*	3	3	3	3	*	4	*

Pit clear opening span (S)	Cover type	Standard pit clear opening length (L)											
		2850	2900	3000	3150	3300	3400	3550	3700	3850	3900	4000	4150
300	DLF	*	*	*	*	4	*	*	*	*	*	*	5
450	DMR	4	*	4	4	4	5	5	5	5	*	5	5
600	DMR	4	3	4	4	4	5	5	5	5	4	5	5
750	DMR	4	3	4	4	4	5	5	5	5	4	5	5
900	DMR	4	3	4	4	4	5	5	5	5	4	5	5
1050	DM	4	*	4	4	4	5	5	5	5	*	5	5
1200	DM	4	*	4	4	4	5	5	5	5	*	5	5

\* Indicates standard sizes not available. The number shown indicates the quantity of cover parts. Other standard sizes may be available, refer to our technical department

### Cover types

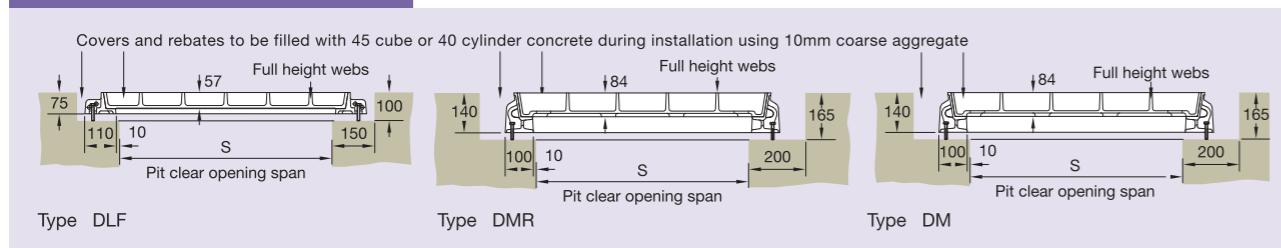

## Solid top duct covers and frames

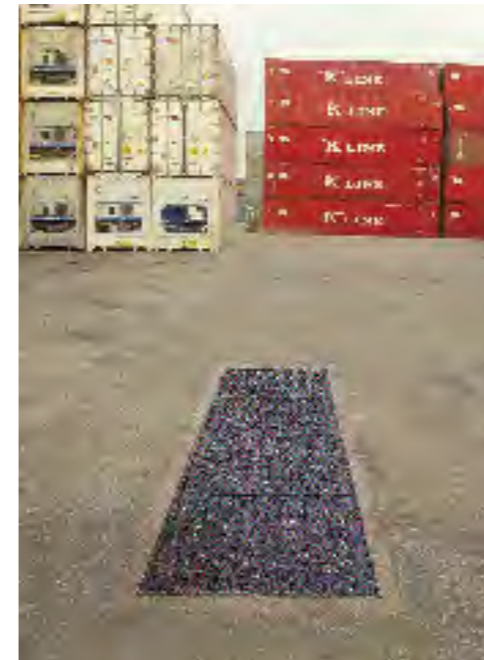

Covers with solid top

Cover type STF

To specify state:

1. Loading group
2. Pit clear opening size length (L) x span (S)
3. Cover type

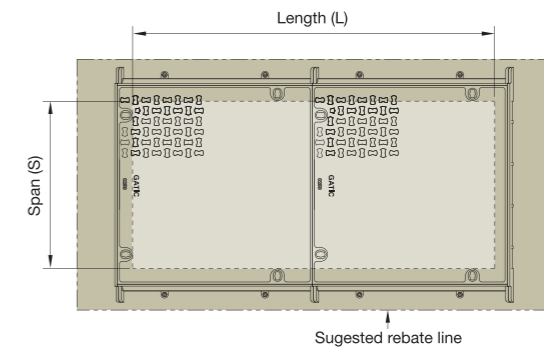

Plan of solid top duct cover

Pit clear opening sizes	Cover type	Suggested rebate size length x width x depth
600	STF	(L + 400) x 1000 x 165
700	STF	(L + 400) x 1100 x 165
750	STF	(L + 400) x 1150 x 165
900	STF	(L + 400) x 1300 x 165

For high density traffic conditions refer to page 14.

Pit clear opening span (S)	Cover type	Standard pit clear opening length (L)												
		1300	1450	1500	1600	1750	1900	2000	2150	2300	2450	2600	2700	2750
600	STF	2	2	*	2	2	2	3	3	3	3	3	4	3
700	STF	*	*	2	*	*	*	*	*	3	*	*	*	*
750	STF	2	2	*	2	2	2	3	3	3	3	3	4	3
900	STF	2	2	*	2	2	2	3	3	3	3	3	4	3

Pit clear opening span (S)	Cover type	Standard pit clear opening length (L)												
		2850	2900	3000	3100	3150	3300	3400	3550	3700	3850	3900	4000	4150
600	STF	4	3	4	*	4	4	5	5	5	5	4	5	5
700	STF	*	*	*	4	*	*	*	*	*	*	5	*	*
750	STF	4	3	4	*	4	4	5	5	5	5	4	5	5
900	STF	4	3	4	*	4	4	5	5	5	5	4	5	5

\* Indicates standard sizes not available. The number shown indicates the quantity of cover parts. Other standard sizes may be available, refer to our technical department

### Cover type

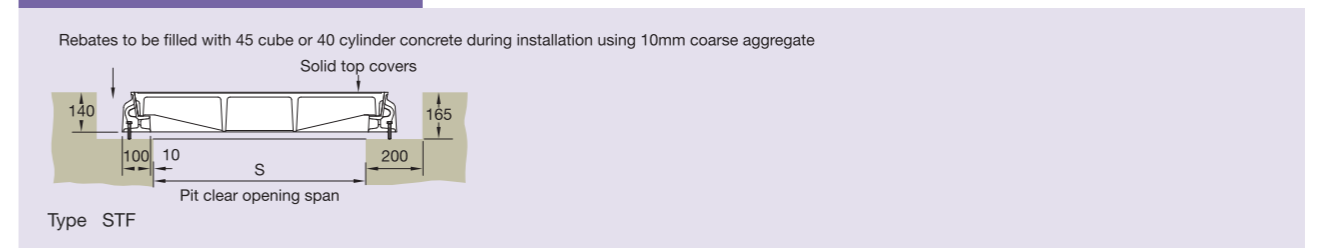



# GATIC

## Continuous recessed trench covers and frames

Covers recessed for concrete infill

Cover types: DLF, DM, DMR, DM/F

To specify state:

1. Loading group
2. Cover type
3. Supply layout drawing of trenches

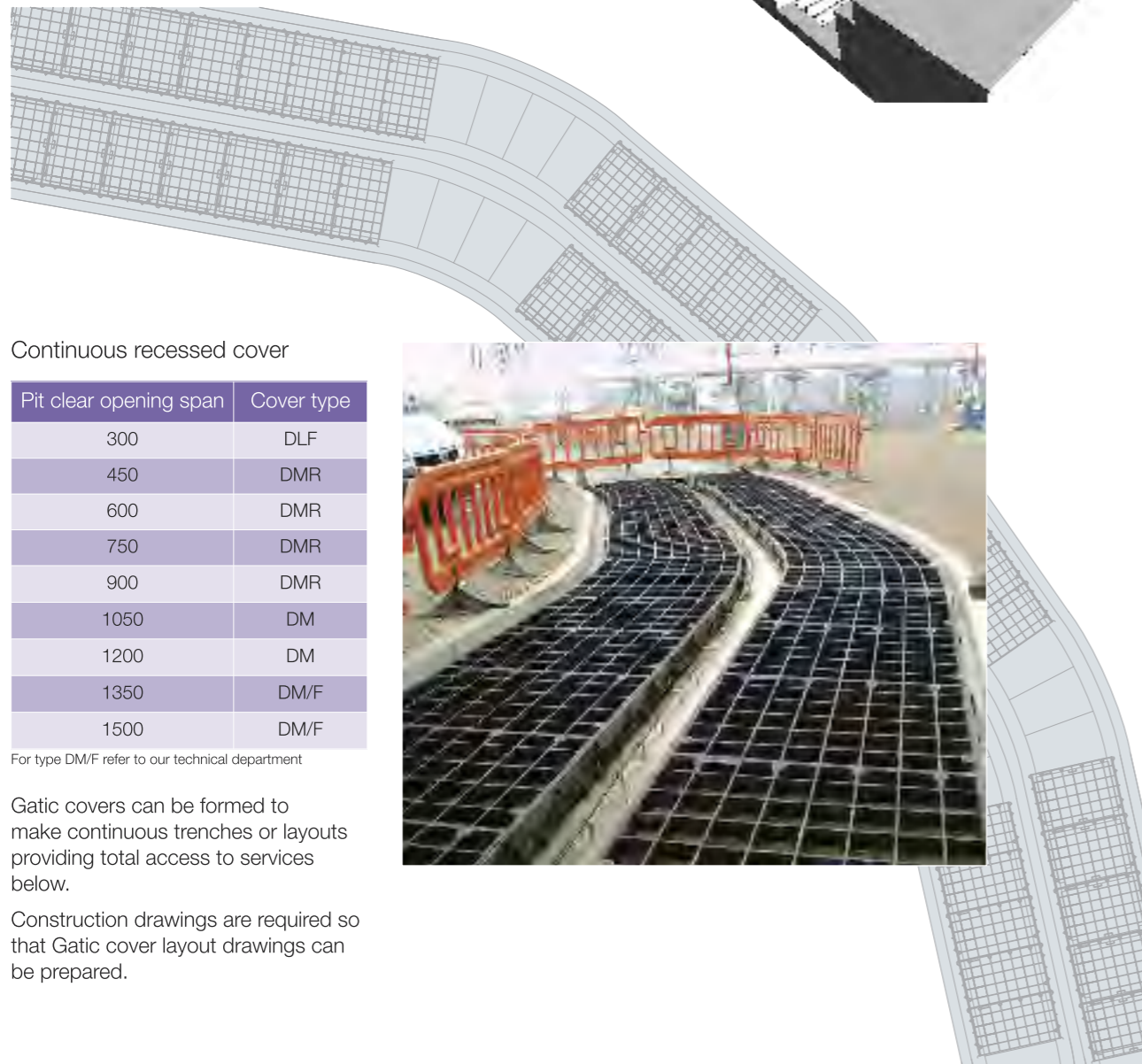
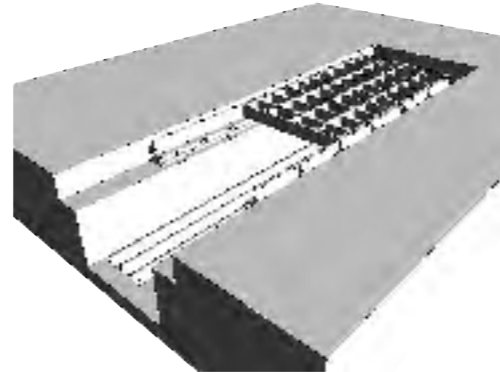

### Continuous recessed cover

Pit clear opening span	Cover type
300	DLF
450	DMR
600	DMR
750	DMR
900	DMR
1050	DM
1200	DM
1350	DM/F
1500	DM/F

For type DM/F refer to our technical department

Gatic covers can be formed to make continuous trenches or layouts providing total access to services below.

Construction drawings are required so that Gatic cover layout drawings can be prepared.

### Cover types

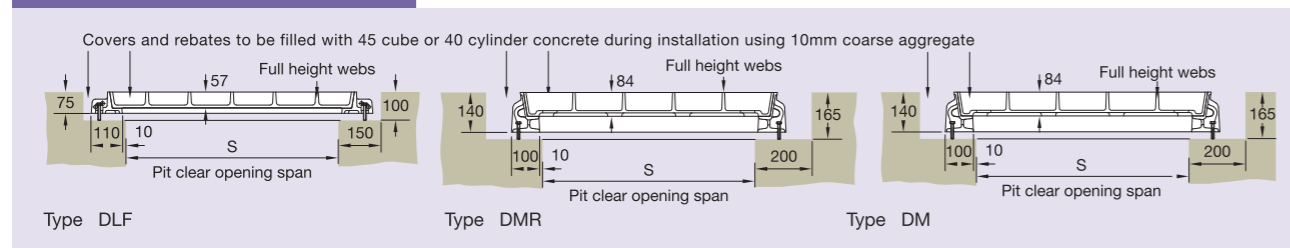

## Continuous solid top trench covers and frames

Covers with solid top

Cover types: STF

To specify state:

1. Loading group
2. Cover type
3. Supply layout drawing of trenches

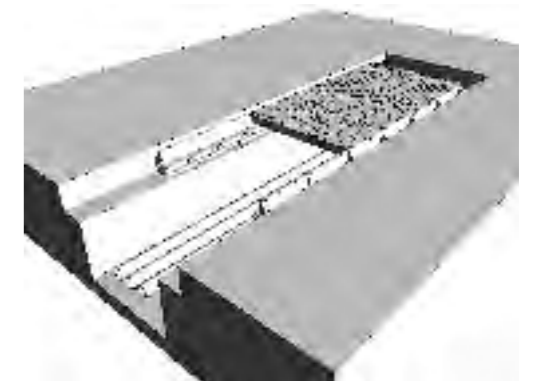

### Continuous solid top cover

Pit clear opening span	Cover type
600	STF
700	STF
750	STF
900	STF

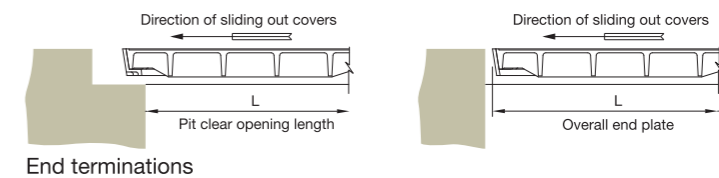

Standard Solid top covers are supplied in straight runs. Junctions and splays can be achieved by the inclusion of localised recessed covers. Refer to our technical department for more information.

For high density traffic conditions refer to page 14.

### Cover type

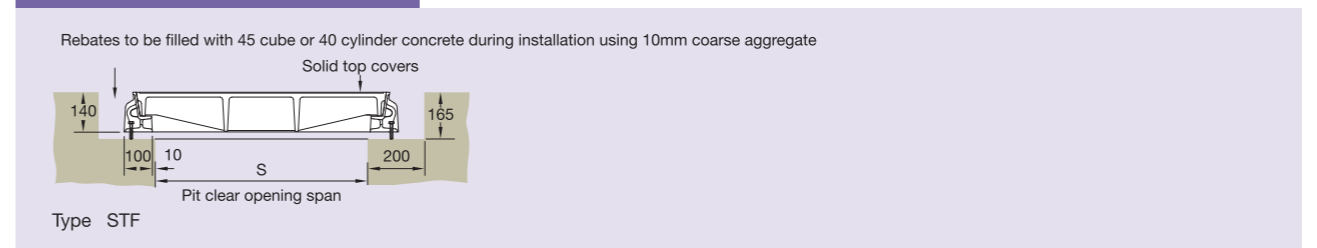



# GATIC

## Multispan covers and frames

### Specification

Below is sample specification information and notes for Multispan recessed covers and frames.

For more details on features and benefits of Gatic covers, see pages 14 to 15.

#### Loading group Gatic E600

20 tonne wheel load – test load 600 kN.

#### Materials

Ductile iron components to BS EN 1563:1997.

Structural steel removable beams to BS 4-1:2005.

#### Finishes

Units coated with black bituminous solution for protection during transit.

Removable supporting steelwork galvanised to BS EN ISO 1461:2009.

#### Infill and surround concrete by customer

Concrete strength, using 10mm coarse aggregate, to be:  
45N/mm<sup>2</sup> for a test cube of 150mm or  
40N/mm<sup>2</sup> for a test cylinder of 150mm diameter x 300mm high.

#### Installation

In accordance with instructions supplied by Gatic.



Type DMR recessed



Type STF solid top

To specify use size and description format as follows:

#### Gatic Multispan Recessed covers and frames Cover type DMR recessed

Multiple access covers recessed for concrete infill with removable beams.

.... in no. .... (length) x .... (span) mm pit clear opening multi span cover and frame.

Gatic Type DMR Ductile Iron Recessed Cover in .... parts complete with

.... in no. .... x .... mm galvanised removable support beam spanning the .... (length) mm way.

Suitable for Loading Group E600 – 20 Tonnes Wheel Load (pneumatic tyre).

#### Gatic Multispan Solid Top covers and frames Cover type STF solid top

Multiple solid top access covers with removable beams.

.... in no. .... (length) x .... (span) mm pit clear opening multi span cover and frame.

Gatic Type STF Ductile Iron Solid Top Cover in .... parts complete with

.... in no. .... x .... mm galvanised removable support beam spanning the .... (length) mm way.

Suitable for Loading Group E600 – 20 Tonnes Wheel Load (pneumatic tyre).

Standard pit clear opening sizes are shown on Page 61.

Beam sizes and other dimensions are shown on Pages 62 and 63.

For high density traffic conditions refer to page 14.

## Multispan covers and frames

### Product Selection

Refer to the table to identify which cover and beam configuration you require against pit clear opening length (L) and pit clear opening span (S). All dimensions are in millimetres.

Note: All dimensions shown in red are made up using 700 x 700 solid top covers only.

		Pit clear opening length (L) mm												Beam centres mm																
		2 parts			3 parts			4 parts						A	B	C	D	E												
		1300	1450	1500	1600	1750	1900	2000	2150	2300	2450	2600	2750	2900	2700	2850	3000	3100	3150	3300	3450	3600	3750	3900						
Pit clear opening span (S) mm	2 parts 1 beam	1380	1530	1580	1680	1830	1980																			690	690			
	2 parts 2 beams	2160	2310	2460	2610	2760	2910	3060																		690	780	690		
3 parts 2 beams	3 parts 3 beams	2940	3090	3240	3390	3540	3690	3840	3990	4140																690	780	780	690	
	4 parts 3 beams	3720	3870	4020	4170	4320	4470	4620	4770	4920	5070	5220														690	780	780	780	690
5 parts 4 beams	5 parts 4 beams	4500	4650	4800	4950	5100	5250	5400	5550	5700	5850	6000														690	780	780	780	690
	6 parts 4 beams	5280	5430	5580	5730	5880	6030	6180	6330	6480	6630	6780														690	780	780	780	690

Note: For other pit clear opening sizes please refer to our technical department



# GATIC

## Multispan covers and frames

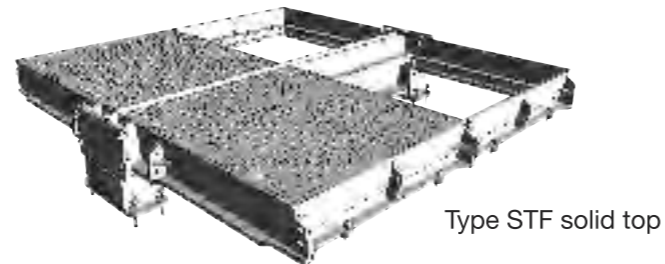
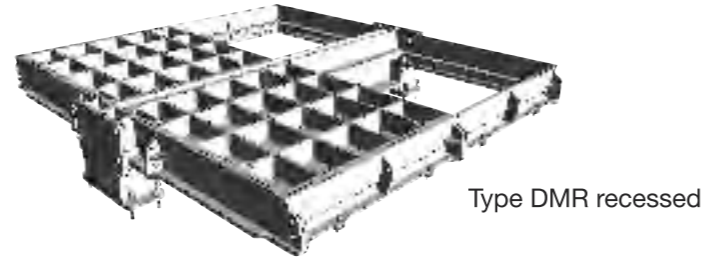

Covers recessed for concrete infill or solid top

Cover types: DMR (recessed)  
STF (solid top)

The details below show plan and sections of a typical recessed/solid top unit.

For selection and specification guidance, refer to pages 60, 61 and 63.

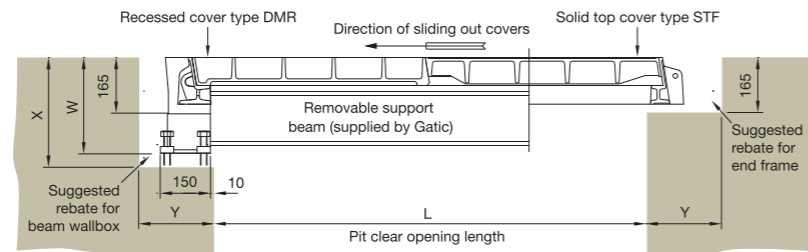

Section A - A

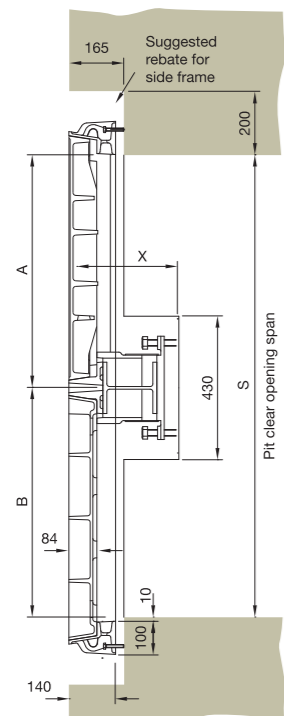

Section B - B

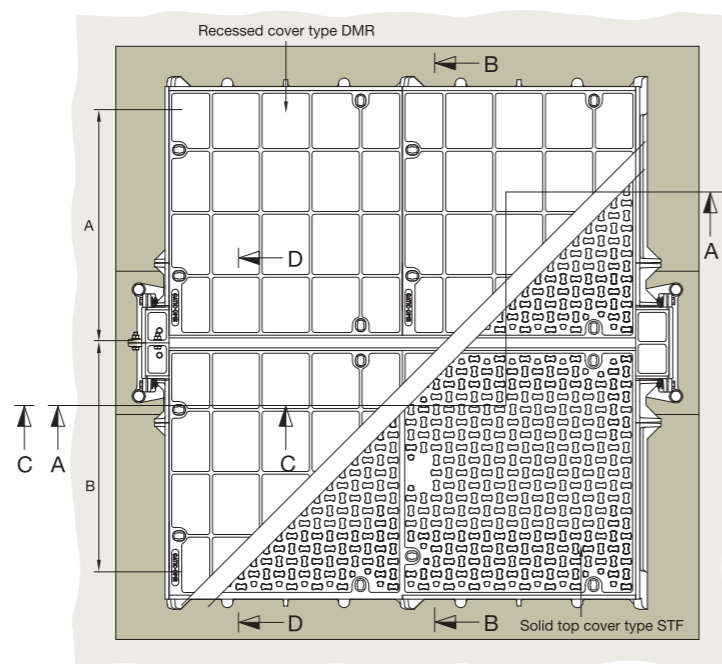

Plan showing recessed and solid top cover options

## Multispan covers and frames

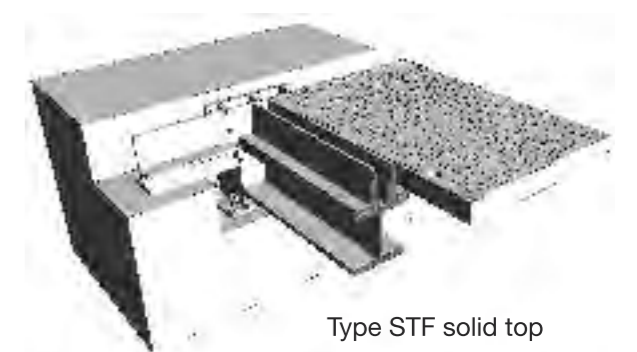
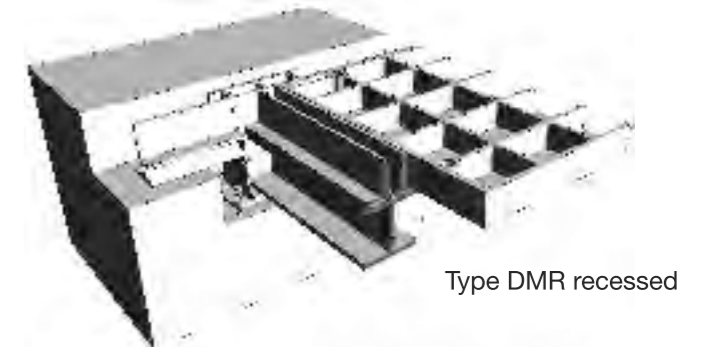

### Beam Size

The required beam size for Multispan covers is dependent on the pit clear opening length and the loading group.

The table shows maximum beam length against beam size. The removable support beams are supplied by Gatic.

The table also indicates dimensions of the beam wallbox and rebate to suit different beam sizes. See also the accompanying section details.

### Support beam size chart

Removable support beam size	Max pit clear opening length (L)	Beam wallbox dimensions			
		V	W	X	Y
203 x 152 x 52kg/m RSJ	1300	306	330	370	230
305 x 165 x 54kg/m UB	1900	414	440	480	230
356 x 171 x 67kg/m UB	2300	467	490	535	300
457 x 152 x 82kg/m UB	2900	568	595	635	300
533 x 210 x 122kg/m UB	3900	648	670	715	300

Note: Removable support beams are supplied by Gatic

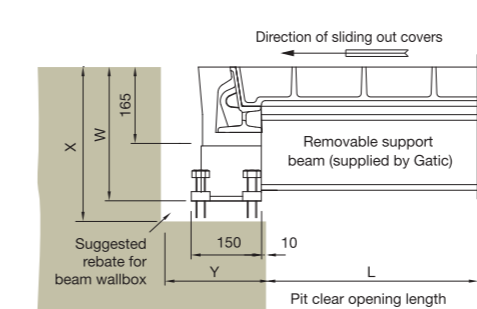

Section C - C

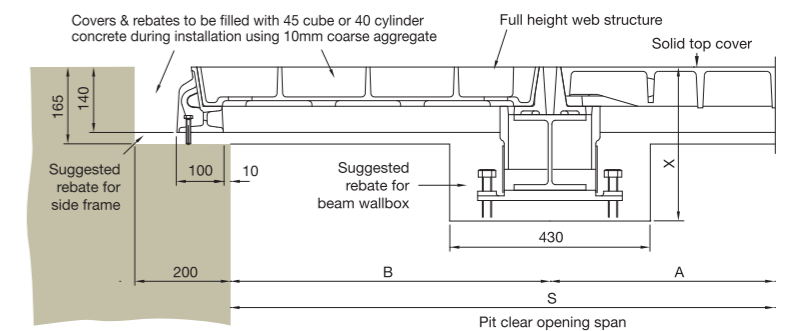

Section D - D





# GATIC Loading Group F900

## Introduction

This section includes Gatic covers and frames designed for Loading Group F900.

In excess of 20 tonne slow moving wheel load, test load 900kN – Suitable for:

Aircraft hardstandings and taxiways at civil airports

Container ports and dockyards where individual wheel loadings exceed 20 tonnes



F900 assemblies are available with a choice of cover designs – recessed or solid top.

### Recessed for concrete infill

Recessed covers are available in a choice of designs designated by a 'Type' reference. F900 recessed covers are available as Type DLF, DM, DMR and DM/F. Section drawings of the different recessed cover types are shown on the following pages.



### Solid top

Solid top cover types are lighter in weight than recessed covers, and feature a figured anti-slip surface. Solid top covers are denoted by the code Type STF depicted in section on the following pages.



To prevent movement of covers in high traffic conditions, we recommend the use of a factory fitted vibration-resistant locking system. Can be fitted to recessed covers only. See page 14.

## Cover types

Single covers and frames



Duct covers and frames



Continuous trench covers and frames

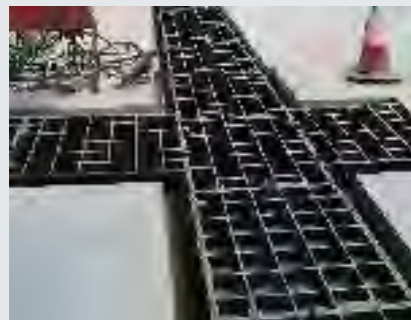

Multispan covers and frames





# GATIC

## Single recessed covers and frames



Covers recessed for concrete infill

Cover type: DLF, DMR, DM

To specify state:

1. Loading group
2. Pit clear opening size length (L) x span (S)
3. Cover type



Pit clear opening sizes L x S	Cover type	Overall frame size length x width x depth	Suggested rebate size length x width x depth
750 x 300	DLF	900 x 540 x 75	1050 x 600 x 100
600 x 450	DMR	750 x 670 x 140	1000 x 850 x 165
750 x 450	DMR	900 x 670 x 140	1150 x 850 x 165
600 x 600	DMR	750 x 820 x 140	1000 x 1000 x 165
750 x 600	DMR	900 x 820 x 140	1150 x 1000 x 165
900 x 600	DMR	1050 x 820 x 140	1300 x 1000 x 165
750 x 750	DMR	900 x 970 x 140	1150 x 1150 x 165
900 x 750	DMR	1050 x 970 x 140	1300 x 1150 x 165
900 x 900	DMR	1120 x 1100 x 140	1300 x 1300 x 165
600 x 1050	DM	820 x 1270 x 140	1000 x 1450 x 165
750 x 1050	DM	970 x 1270 x 140	1150 x 1450 x 165
1000 x 1050	DM	1220 x 1270 x 140	1400 x 1450 x 165
600 x 1200	DM	820 x 1420 x 140	1000 x 1600 x 165
750 x 1200	DM	970 x 1420 x 140	1150 x 1600 x 165

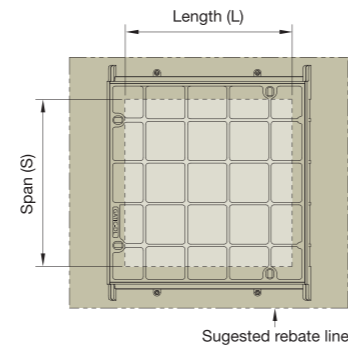

Plan of recessed single cover

## Single solid top covers and frames



Covers with solid top

Cover type STF

To specify state:

1. Loading group
2. Pit clear opening size length (L) x span (S)
3. Cover type



Pit clear opening sizes L x S	Cover type	Overall frame size length x width x depth	Suggested rebate size length x width x depth
600 x 600	STF	750 x 820 x 140	1000 x 1000 x 165
750 x 600	STF	900 x 820 x 140	1150 x 1000 x 165
900 x 600	STF	1050 x 820 x 140	1300 x 1000 x 165
700 x 700	STF	850 x 920 x 140	1100 x 1100 x 165
750 x 750	STF	900 x 970 x 140	1150 x 1150 x 165
900 x 750	STF	1050 x 970 x 140	1300 x 1150 x 165
900 x 900	STF	1120 x 1120 x 140	1300 x 1300 x 165

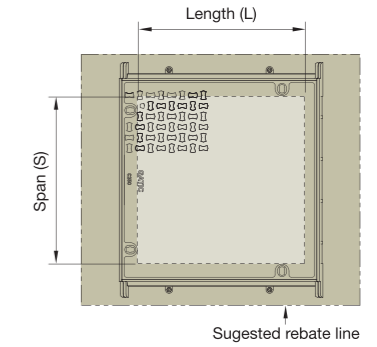

Plan of solid top single cover

For high density traffic conditions refer to page 14.

### Cover types

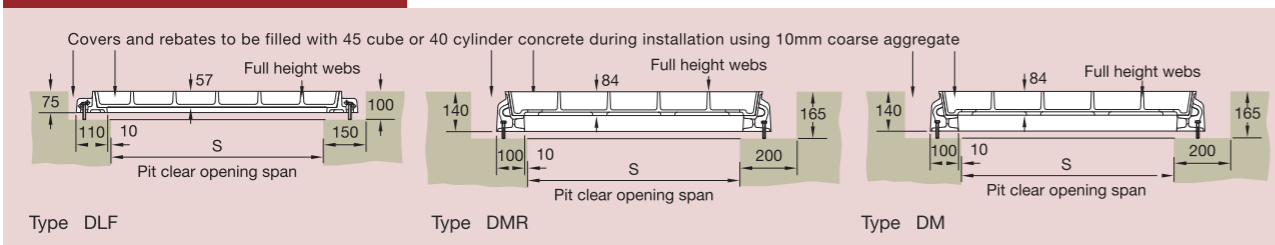

### Cover type

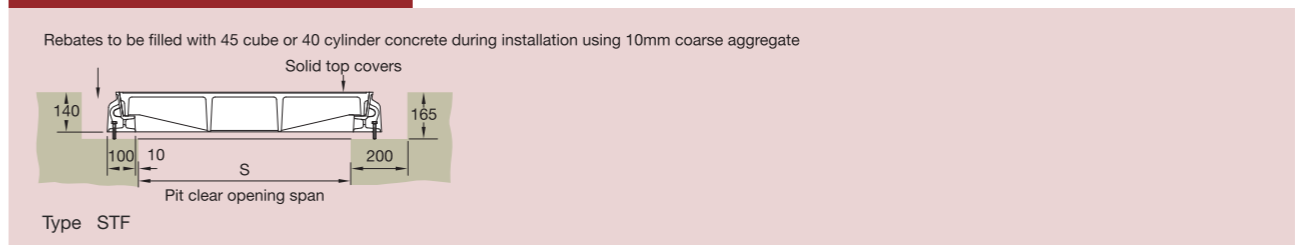



# GATIC

## Recessed duct covers and frames



Covers recessed for concrete infill

Cover type DLF, DMR, DM/F

To specify state:

1. Loading group
2. Pit clear opening size length (L) x span (S)
3. Cover type

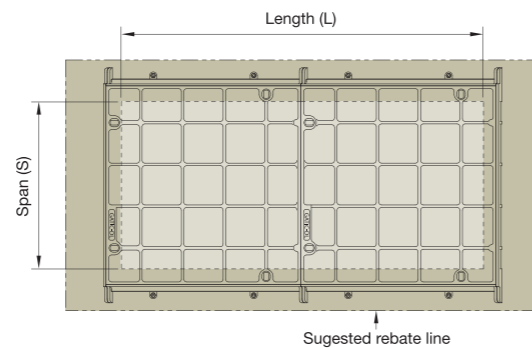

Plan of recessed duct cover

Pit clear opening sizes	Cover type	Suggested rebate size length x width x depth
300	DLF	(L + 300) x 600 x 100
450	DMR	(L + 400) x 850 x 165
600	DMR	(L + 400) x 1000 x 165
750	DMR	(L + 400) x 1150 x 165
900	DMR	(L + 400) x 1300 x 165
1050	DM/F	(L + 400) x 1450 x 165
1200	DM/F	(L + 400) x 1600 x 165
1350	Refer to our technical department	
1500	Refer to our technical department	

Pit clear opening span (S)	Cover type	Standard pit clear opening length (L)											
		1300	1450	1600	1750	1900	2000	2150	2300	2450	2600	2700	2750
300	DLF	*	*	2	*	*	*	*	*	3	*	*	*
450	DMR	2	2	2	*	*	3	3	3	3	*	4	*
600	DMR	2	2	2	2	2	3	3	3	3	3	4	3
750	DMR	2	2	2	2	2	3	3	3	3	3	4	3
900	DMR	2	2	2	2	2	3	3	3	3	3	4	3
1050	DM/F	2	2	2	*	*	3	3	3	3	*	4	*
1200	DM/F	2	2	2	*	*	3	3	3	3	*	4	*

Pit clear opening span (S)	Cover type	Standard pit clear opening length (L)											
		2850	2900	3000	3150	3300	3400	3550	3700	3850	3900	4000	4150
300	DLF	*	*	*	*	4	*	*	*	*	*	*	5
450	DMR	4	*	4	4	4	5	5	5	5	*	5	5
600	DMR	4	3	4	4	4	5	5	5	5	4	5	5
750	DMR	4	3	4	4	4	5	5	5	5	4	5	5
900	DMR	4	3	4	4	4	5	5	5	5	4	5	5
1050	DM/F	4	*	4	4	4	5	5	5	5	*	5	5
1200	DM/F	4	*	4	4	4	5	5	5	5	*	5	5

\* Indicates standard sizes not available. The number shown indicates the quantity of cover parts. Other standard sizes may be available, refer to our technical department.

### Cover types

Covers and rebates to be filled with 45 cube or 40 cylinder concrete during installation using 10mm coarse aggregate

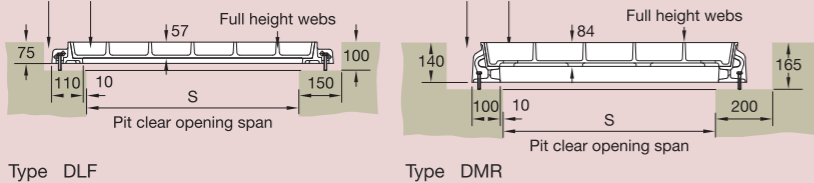

Type DLF

Type DMR

## Solid top duct covers and frames



Covers with solid top

Cover type STF

To specify state:

1. Loading group
2. Pit clear opening size length (L) x span (S)
3. Cover type

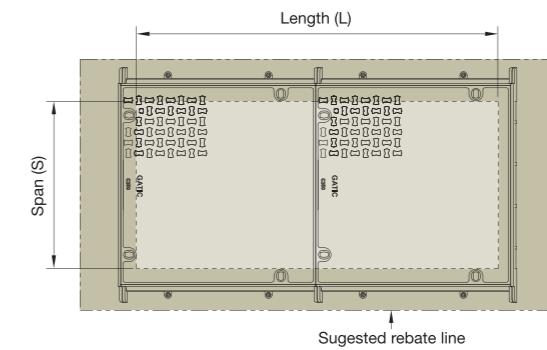

Plan of solid top duct cover

Pit clear opening sizes	Cover type	Suggested rebate size length x width x depth
600	STF	(L + 400) x 1000 x 165
700	STF	(L + 400) x 1100 x 165
750	STF	(L + 400) x 1150 x 165
900	STF	(L + 400) x 1300 x 165

For high density traffic conditions refer to page 14.

Pit clear opening span (S)	Cover type	Standard pit clear opening length (L)												
		1300	1450	1500	1600	1750	1900	2000	2150	2300	2450	2600	2700	2750
600	STF	2	2	*	2	2	2	3	3	3	3	3	4	3
700	STF	*	*	2	*	*	*	*	*	3	*	*	*	*
750	STF	2	2	*	2	2	2	3	3	3	3	3	4	3
900	STF	2	2	*	2	2	2	3	3	3	3	3	4	3

Pit clear opening span (S)	Cover type	Standard pit clear opening length (L)												
		2850	2900	3000	3100	3150	3300	3400	3550	3700	3850	3900	4000	4150
600	STF	4	3	4	*	4	4	5	5	5	5	4	5	5
700	STF	*	*	*	4	*	*	*	*	*	*	5	*	*
750	STF	4	3	4	*	4	4	5	5	5	5	4	5	5
900	STF	4	3	4	*	4	4	5	5	5	5	4	5	5

\* Indicates standard sizes not available. The number shown indicates the quantity of cover parts. Other standard sizes may be available, refer to our technical department.

### Cover type

Rebates to be filled with 45 cube or 40 cylinder concrete during installation using 10mm coarse aggregate

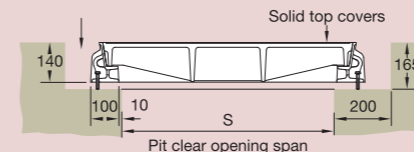

Type STF



# GATIC

## Continuous recessed trench covers and frames



Covers recessed for concrete infill

Cover types: DLF, DMR, DM/F

To specify state:

1. Loading group
2. Cover type
3. Supply layout drawing of trenches

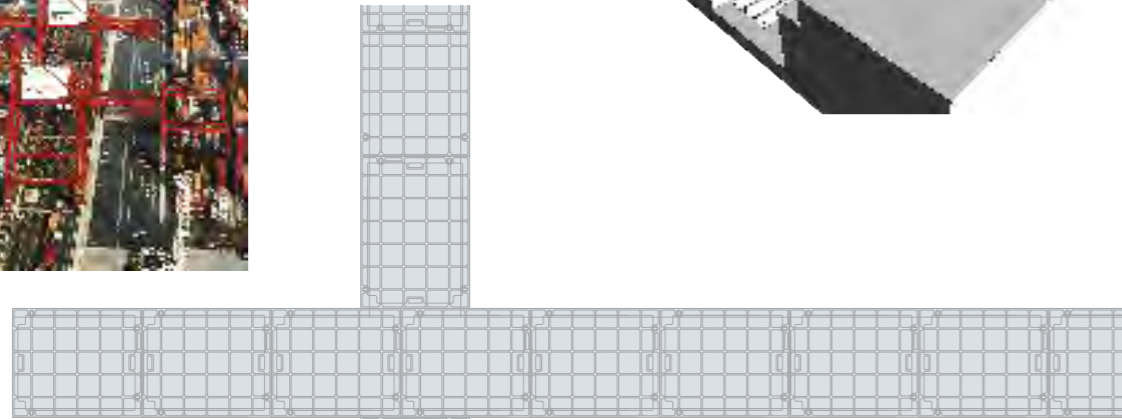
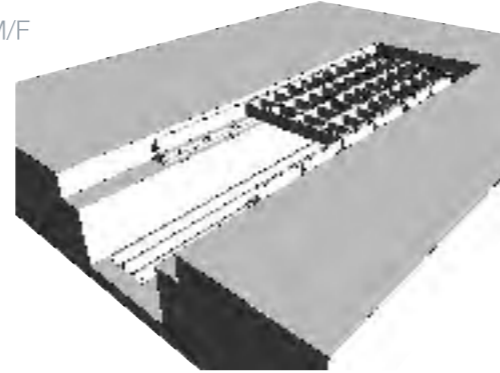

### Continuous recessed cover

Pit clear opening span	Cover type
300	DLF
450	DMR
600	DMR
750	DMR
900	DMR
1050	DM/F
1200	DM/F
1350	DM/F
1500	DM/F

For Type DM/F 1050,1200,1350 and 1500 spans refer to our technical department

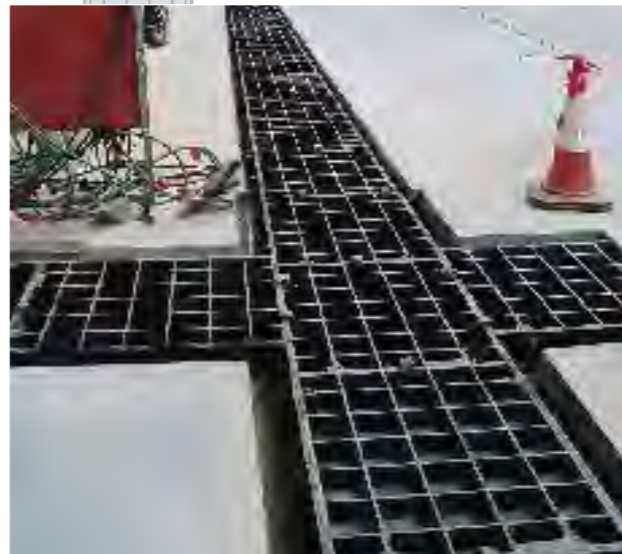

Gatic covers can be formed to make continuous trenches or layouts providing total access to services below.

Construction drawings are required so that Gatic cover layout drawings can be prepared.

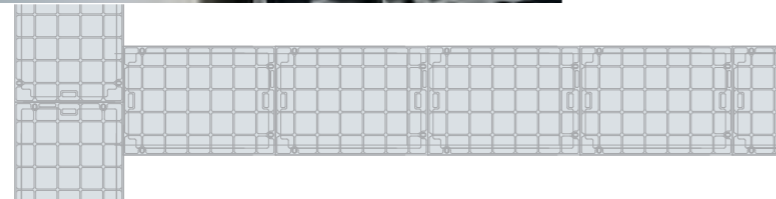

### Cover types

Covers and rebates to be filled with 45 cube or 40 cylinder concrete during installation using 10mm coarse aggregate

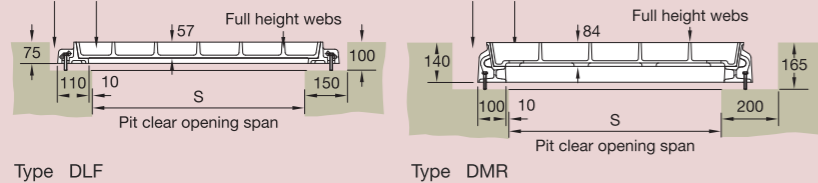

Type DLF

Type DMR

## Continuous solid top trench covers and frames



Covers with solid top

Cover types: STF

To specify state:

1. Loading group
2. Cover type
3. Supply layout drawing of trenches

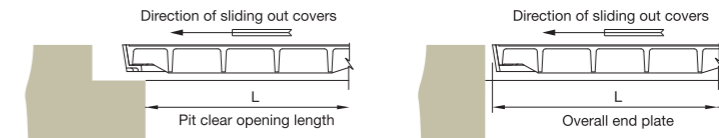
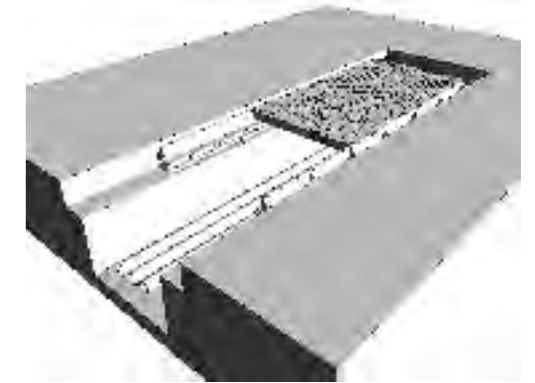

End terminations

### Continuous solid top cover

Pit clear opening span	Cover type
600	STF
700	STF
750	STF
900	STF

Note: Solid top covers can only be supplied in continuous straight runs

Standard Solid top covers are supplied in straight runs. Junctions and splays can be achieved by the inclusion of localised recessed covers. Refer to our technical department for more information.

For high density traffic conditions refer to page 14.



### Cover type

Rebates to be filled with 45 cube or 40 cylinder concrete during installation using 10mm coarse aggregate

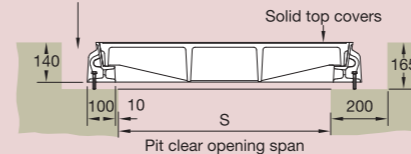

Type STF



# GATIC

## Multispan covers and frames

### Specification

Below is sample specification information and notes for Multispan recessed covers and frames.

For more details on features and benefits of Gatic covers, see pages 14 to 15.

#### Loading group Gatic F900

In excess of 20 tonne wheel load – test load 900 kN.

#### Materials

Ductile iron components to BS EN 1563:1997.

Structural steel removable beams to BS 4-1:2005.

#### Finishes

Units coated with black bituminous solution for protection during transit.

Removable supporting steelwork galvanised to BS EN ISO 1461:2009.

#### Infill and surround concrete by customer

Concrete strength, using 10mm coarse aggregate, to be:

45N/mm<sup>2</sup> for a test cube of 150mm or

40N/mm<sup>2</sup> for a test cylinder of 150mm diameter x 300mm high.

#### Installation

In accordance with instructions supplied by Gatic.



Type DMR recessed

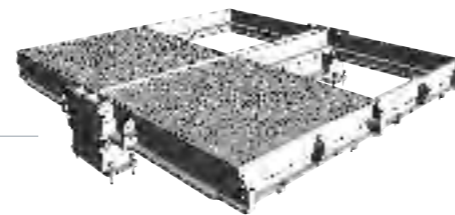

Type STF solid top

To specify use size and description format as follows:

#### Gatic Multispan Recessed covers and frames Cover type DMR recessed

Multiple access covers recessed for concrete infill with removable beams.

.... in no. .... (length) x .... (span) mm pit clear opening multi span cover and frame.

Gatic Type DMR Ductile Iron Recessed Cover in .... parts complete with

.... in no. .... x .... mm galvanised removable support beam spanning the .... (length) mm way.

Suitable for Loading Group F900 – In excess of 20 Tonnes Wheel Load (pneumatic tyre).

#### Gatic Multispan Solid Top covers and frames Cover type STF solid top

Multiple solid top access covers with removable beams.

.... in no. .... (length) x .... (span) mm pit clear opening multi span cover and frame.

Gatic Type STF Ductile Iron Solid Top Cover in .... parts complete with

.... in no. .... x .... mm galvanised removable support beam spanning the .... (length) mm way.

Suitable for Loading Group F900 – In excess of 20 Tonnes Wheel Load (pneumatic tyre).

Standard pit clear opening sizes are shown on Page 73.

Beam sizes and other dimensions are shown on Pages 74 and 75.

For high density traffic conditions refer to page 14.

## Multispan covers and frames

### Product Selection

Refer to the table to identify which cover and beam configuration you require against pit clear opening length (L) and pit clear opening span (S). All dimensions are in millimetres.

Note: All dimensions shown in red are made up using 700 x 700 solid top covers.

Pit clear opening span (S) mm		Pit clear opening length (L) mm			Beam centres mm				
		2 parts	3 parts	4 parts	A	B	C	D	E
		1300 1450 <b>1500</b> 1600 1750 1900	2000 2150 <b>2300</b> 2300 2450 2600 2750 2900	2700 2850 3000 <b>3100</b> 3150 3300 3450 3600 3750 3900					
1 beam	1380								
	1530								
2 parts	<b>1580</b>				690	690			
	1680				840	690			
3 parts	1830				840	840			
	1980				990	840			
4 parts	2160				990	990			
	2310				690	780	690		
2 beams	2310				690	930	690		
	2460				840	780	840		
3 parts	<b>2460</b>				<b>790</b>	<b>880</b>	<b>790</b>		
	2610				840	930	840		
4 parts	2760				840	1080	840		
	2910				990	930	990		
5 parts	3060				990	1080	990		
	2940				690	780	780	690	
3 beams	3090				840	780	780	690	
	3240				840	780	780	840	
4 parts	<b>3340</b>				<b>790</b>	<b>880</b>	<b>880</b>	<b>790</b>	
	3390				840	930	930	690	
5 parts	3540				840	930	930	840	
	3690				990	930	930	840	
6 parts	3840				990	930	930	990	
	3990				990	1080	1080	840	
7 parts	4140				990	1080	1080	990	
	3720				690	780	780	690	
4 beams	3870				690	780	930	780	690
	4020				840	780	780	780	840
5 parts	4170				690	930	930	930	690
	<b>4220</b>				<b>790</b>	<b>880</b>	<b>880</b>	<b>880</b>	<b>790</b>
6 parts	4320				840	930	780	930	840
	4470				840	930	930	930	840
7 parts	4620				840	930	1080	930	840
	4770				990	930	930	930	990
8 parts	4920				990	930	1080	930	990
	5070				990	1080	930	1080	990
9 parts	5220				990	1080	1080	1080	990

Note: For other pit clear opening sizes please refer to our technical department



# GATIC

## Multispan covers and frames

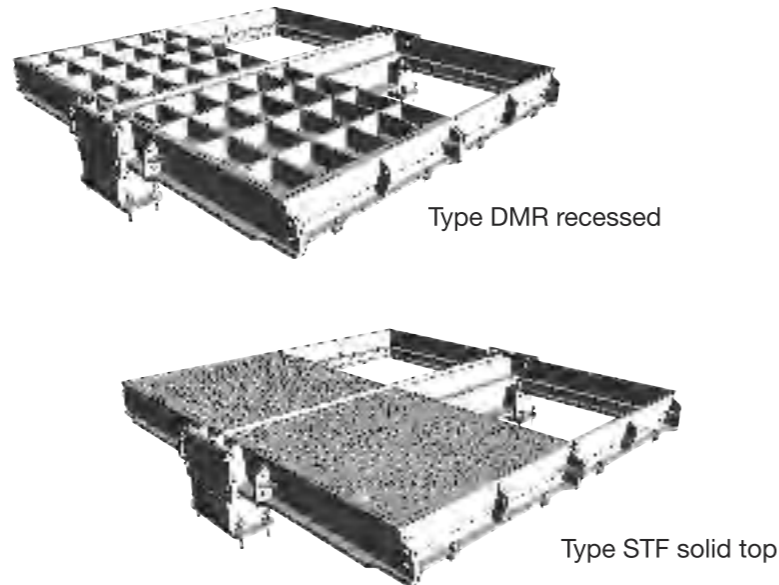

Covers recessed for concrete infill or solid top

Cover types: DMR (recessed)  
STF (solid top)

The details below show plan and sections of a typical recessed/solid top unit.

For selection and specification guidance, refer to pages 72, 73 and 75.

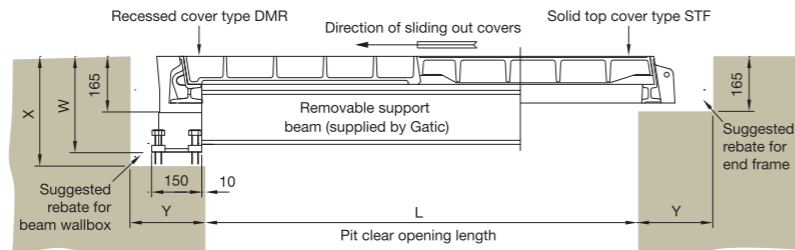

Section A - A

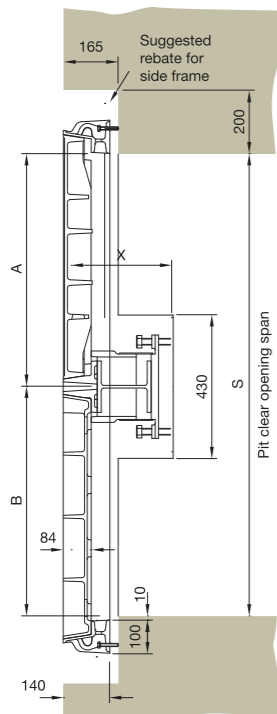

Section B - B

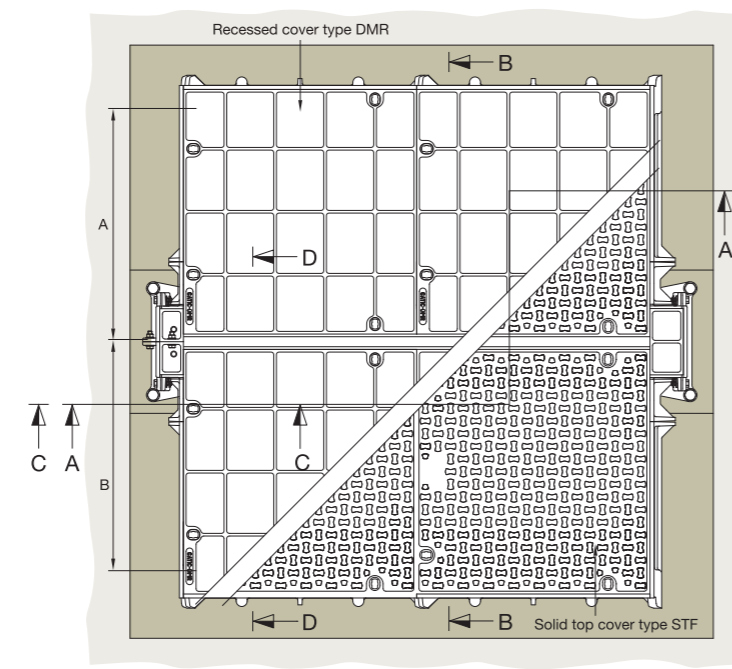

Plan showing recessed and solid top cover options

## Multispan covers and frames

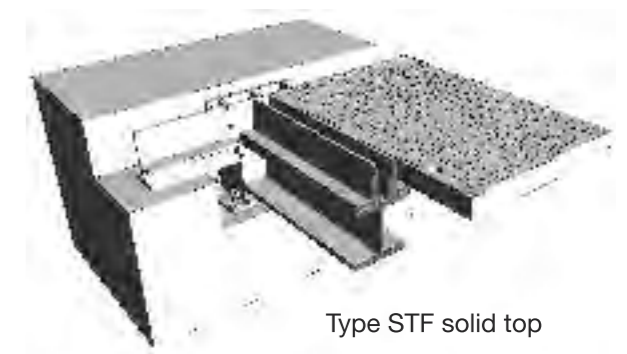
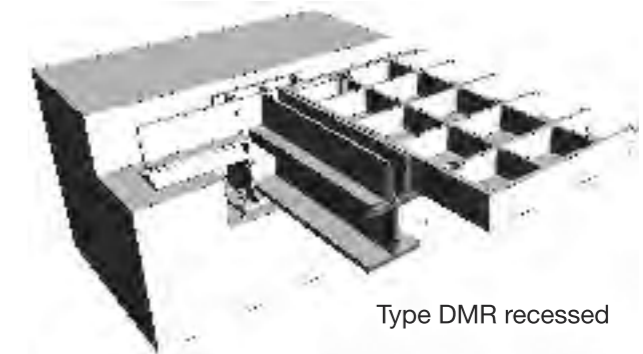

### Beam Size

The required beam size for Multispan covers is dependent on the pit clear opening length and the loading group.

The table shows maximum beam length against beam size. The removable support beams are supplied by Gatic.

The table also indicates dimensions of the beam wallbox and rebate to suit different beam sizes. See also the accompanying section details.

### Support beam size chart

Removable support beam size	Max pit clear opening length (L)	Beam wallbox dimensions			
		V	W	X	Y
356 x 171 x 67kg/m UB	1750	467	490	535	300
457 x 152 x 82kg/m UB	2300	568	595	635	300
533 x 210 x 122kg/m UB	3300	648	670	715	300
610 x 229 x 140kg/m UB	3900	720	745	790	300

Note: Removable support beams are supplied by Gatic

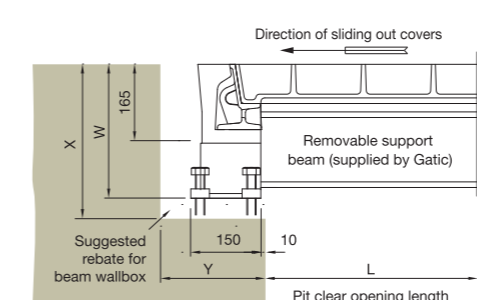

Section C - C

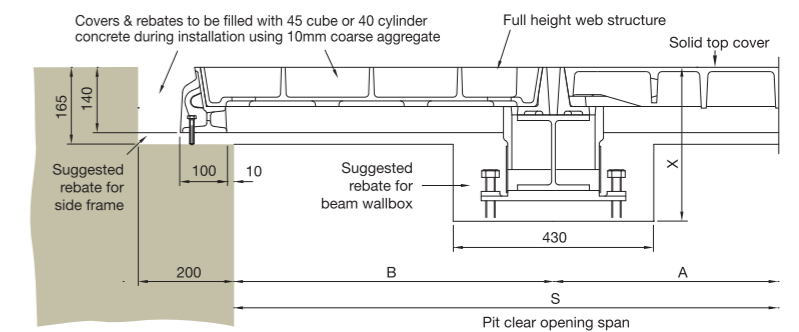

Section D - D

# GATIC Special range of access covers and drainage gratings

## Introduction

Gatic has developed a specialised range of products suitable for loading groups up to F900.

### This section covers:

- Solid top spring assisted covers
- Gas assisted covers
- Hinged hydrant covers
- Circular covers
- Hinged safety grids
- Galvanised covers and gratings
- Gratings and frames
- Plug covers and cut outs

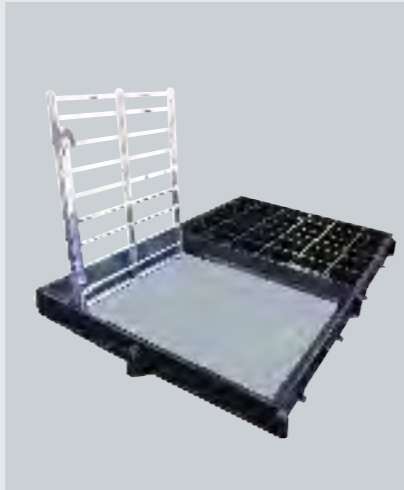

Hinged safety grids Page 80



Circular covers Page 81



Gratings and frames Page 82-83



Spring assisted lift covers Page 78



Hydrant covers Page 81

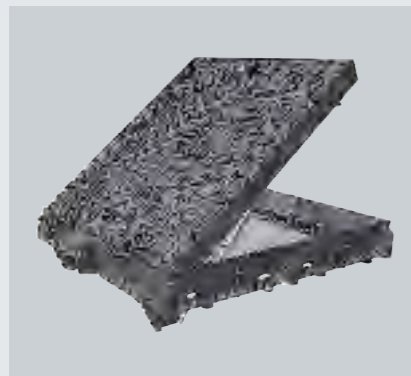

Gas assisted lift covers Page 79

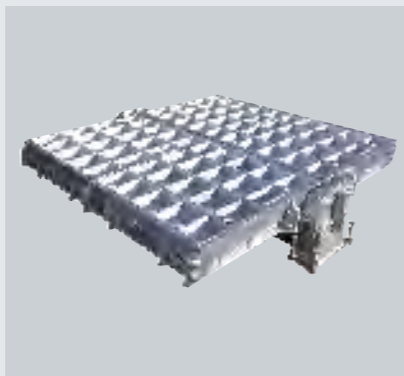

Galvanised covers and gratings Page 80

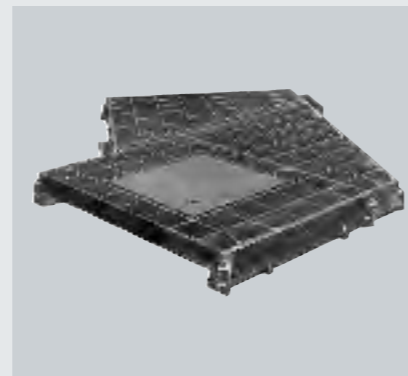

Plug Covers and Cut Outs Page 84

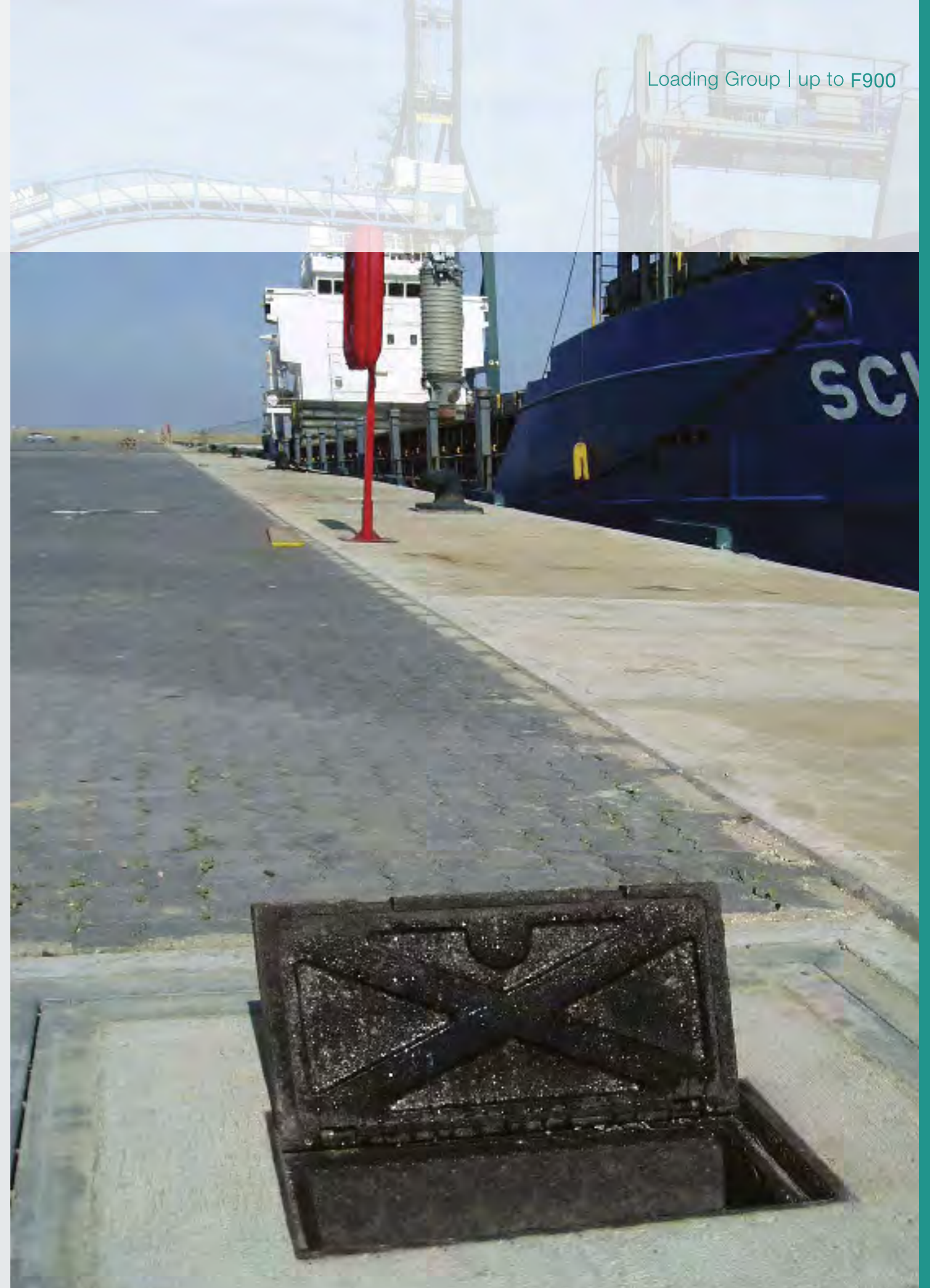

# GATIC

## Special range of access covers



### Solid top spring assisted covers

Spring assist lift covers are recommended for use where regular access is required, and are designed for single person operation. The spring assist lift cover has a maximum operating weight of approximately 15kg.

The units are fitted with flush hinges and can be opened from the side of the pit allowing maximum access to equipment.

- To specify state:
1. Loading group
  2. Pit clear opening size length (L) x span (S)
  3. Cover type

#### Single

Pit clear opening sizes	Cover type	Overall frame size length x width x depth	Suggested rebate size length x width x depth
750 x 750	SSA	970 x 970 x 115	1050 x 1050 x 140
900 x 900	SSA	1120 x 1120 x 115	1200 x 1200 x 140

#### Double

Pit clear opening sizes	Cover type	Overall frame size length x width x depth	Suggested rebate size length x width x depth
1550 x 750	SSA	1740 x 970 x 115	1850 x 1050 x 140
1850 x 900	SSA	2040 x 1120 x 115	2300 x 1200 x 140

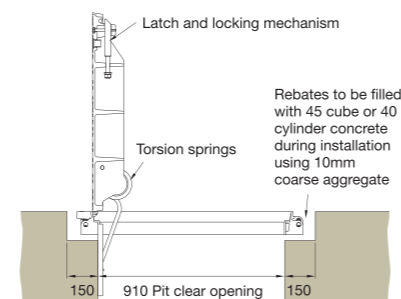
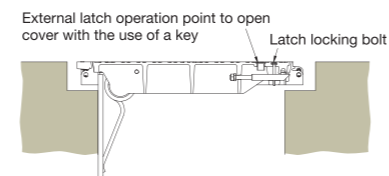

## Special range of access covers

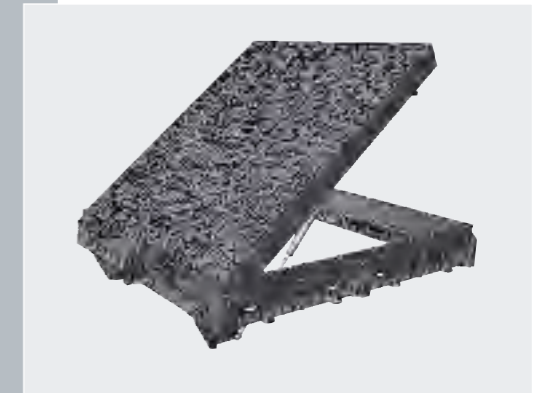
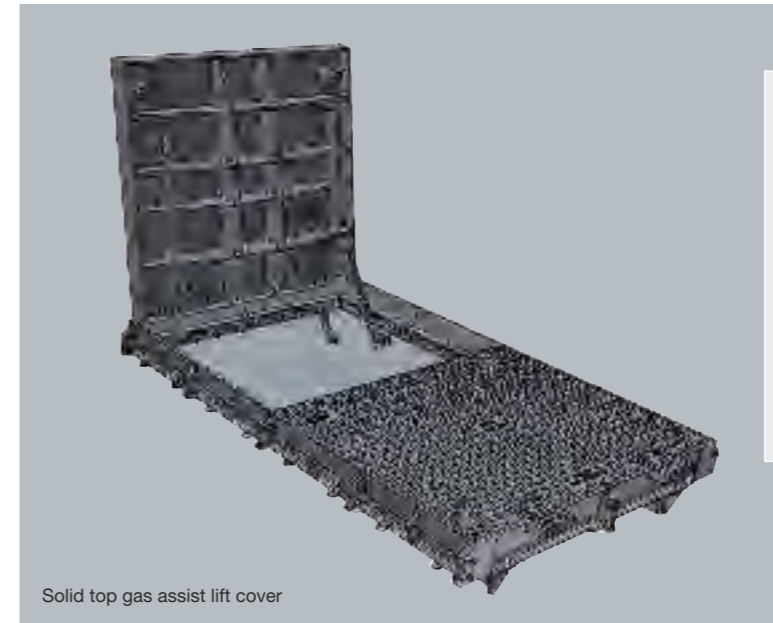

Solid top gas assist lift cover



Recessed gas assist lift cover

- To specify state:
1. Loading group
  2. Pit clear opening size length (L) x span (S)
  3. Cover type

### Solid and recessed top gas assisted covers

Gas Assist lift covers are recommended for use where regular access is required, and are designed for single person operation. The gas assist lift cover has a Maximum operating weight of approximately 25kg.

The units are fitted with flush hinges and can be fitted within larger units including ducts or multispan units.

For more details or information on other sizes refer to our technical department.

#### Solid top or recessed

Pit clear opening sizes	Cover type	Overall frame size length x width x depth	Suggested rebate size length x width x depth
900 x 900 (Solid)	SGA	1120 x 1120 x 140	1300 x 1300 x 165
900 x 900 (recessed)	RGA	1120 x 1120 x 140	1300 x 1300 x 165

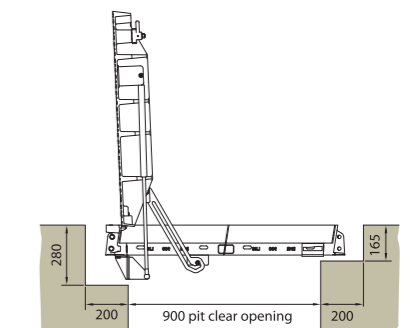

Solid top cover, Type SGA

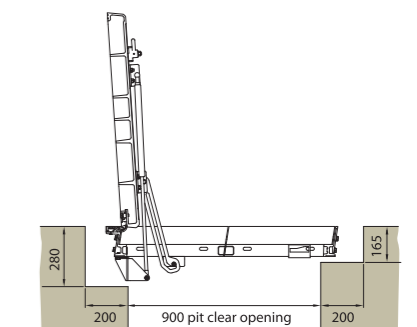

Recessed cover, Type RGA



# GATIC

## Special range of access covers

### Hinged safety grids

Gatic covers can be supplied with mild steel galvanised safety grids when required. Once the cover is removed, the safety grid can be hinged to the vertical position where it will lock safely in place. Safety grids can be locked in a closed position by using customer-supplied padlocks.

Hinged safety grills can be fitted to all gatic units from single covers to multispan.

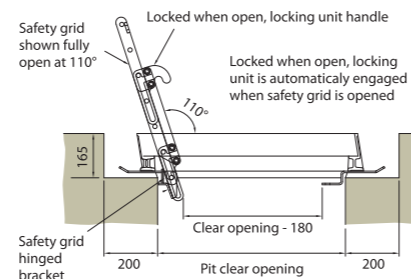
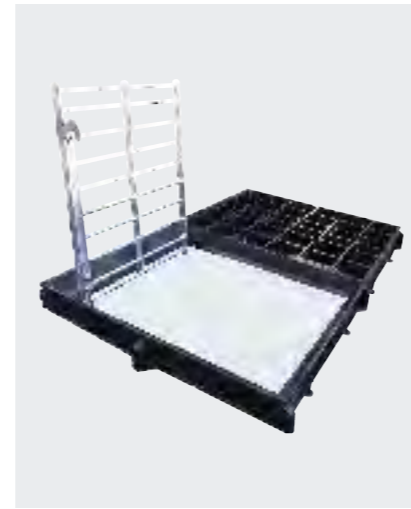
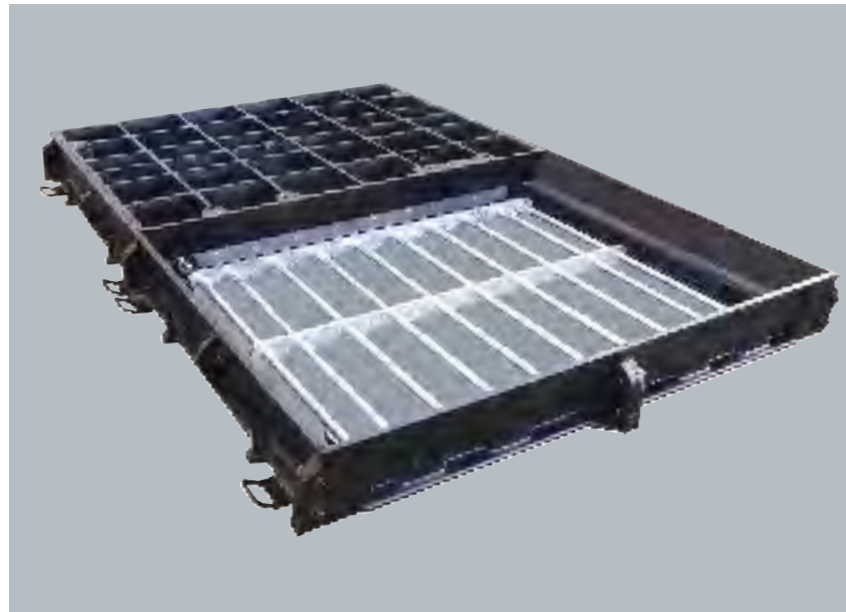

### Alternative finish galvanised covers and gratings

Gatic covers and gratings are supplied painted with black bituminous paint as standard. This acts as temporary protection during transit. Where additional protection is required, Gatic ductile iron covers can be supplied galvanised to BS EN ISO 1461:2009. Refer to Gatic technical department for more information.

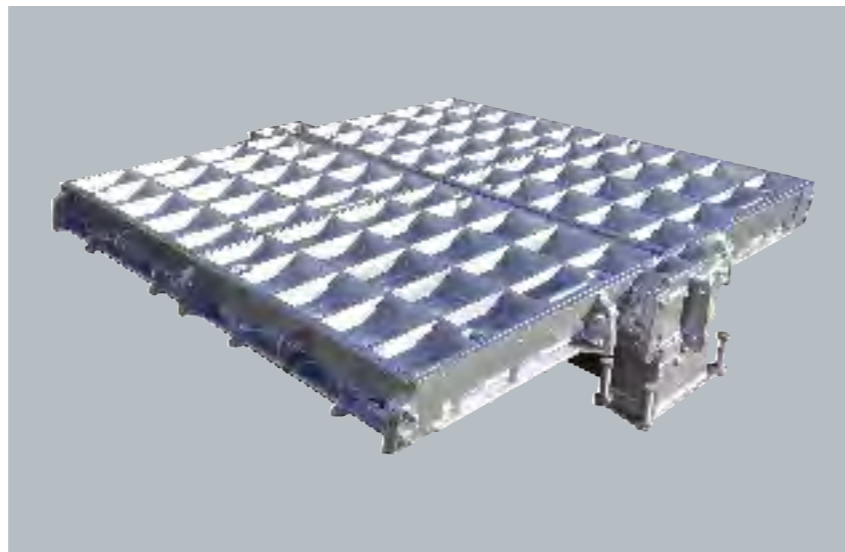

# GATIC

## Special range of access covers

### Hinged hydrant covers

Hydrant lids can be supplied as single covers or set into a larger cover. This provides localised access without removing the larger cover.

Hydrants fitted within larger covers are 400 x 300 clear opening, centrally positioned.

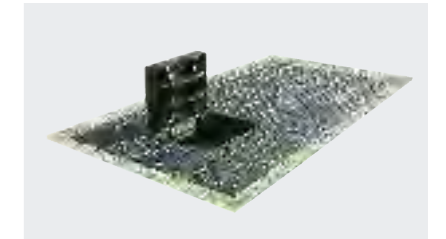

Double hydrant covers

To specify state:

1. Loading group
2. Pit clear opening size length (L) x span (S)
3. Cover type

Single and double covers fitted with 400 x 300 hinged hydrant

Pit clear opening sizes	Cover type	Overall frame size length x width x depth	Suggested rebate size length x width x depth
700 x 700	MHS/H	850 x 920 x 140	1100 x 1100 x 165
900 x 900	MHS/H	850 x 920 x 140	1300 x 1300 x 165
1500 x 700	MHS/H	1720 x 920 x 140	1900 x 1100 x 165
1900 x 900	MHS/H	2120 x 1120 x 140	2300 x 1300 x 165

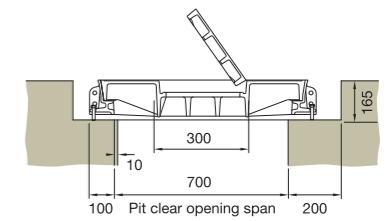

Single and double units - including a 400 x 300 hinged hydrant cover centrally positioned in each cover

### Hydrant covers

Pit clear opening sizes	Cover type	Overall frame size length x width x depth	Suggested rebate size length x width x depth
225 x 225	FH	391 x 391 x 150	525 x 525 x 175
450 x 250	FH	616 x 416 x 150	750 x 550 x 175
500 x 250	FH	666 x 416 x 150	800 x 550 x 175

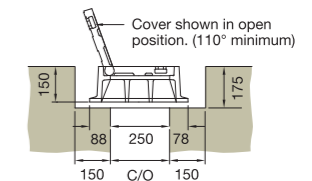

### Solid top circular covers

Suitable for up to F900 loading.

To specify state:

1. Loading group
2. Pit clear opening size length (L) x span (S)
3. Cover type

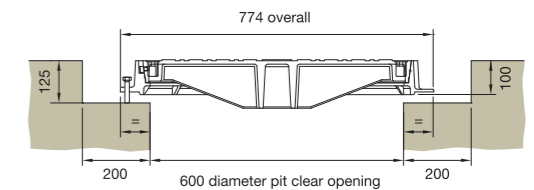

Pit clear opening sizes	Cover type	Overall frame size length x width x depth	Suggested rebate size length x width x depth
600mm diameter	GC	775 diameter	1000 diameter
750mm diameter	GC	1000 diameter	1150 diameter

# GATIC

## Special range of drainage gratings



### Single gratings and frames

Drainage gratings are supplied where surface water drainage is required.

To specify state:

1. Loading group
2. Pit clear opening size length (L) x span (S)
3. Grating type



### Single gratings

Pit clear opening sizes	Grating type	Overall frame size length x width x depth	Suggested rebate size length x width x depth	Waterway per unit
850 x 300	DRG/140	870 x 480 x 140	1000 x 700 x 165	1256cm <sup>2</sup>
850 x 450	DRG/140	870 x 630 x 140	1000 x 850 x 165	2215cm <sup>2</sup>
850 x 600	DMG	870 x 780 x 140	1000 x 1000 x 165	2768cm <sup>2</sup>
700 x 750	DMG	720 x 970 x 140	850 x 1150 x 165	2290cm <sup>2</sup>

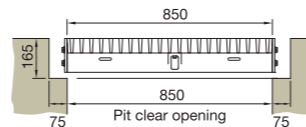

Rebates to be filled with 45 cube or 40 cylinder concrete during installation using 10mm coarse aggregate

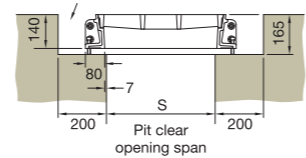

Type DRG/140

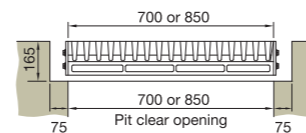

Rebates to be filled with 45 cube or 40 cylinder concrete during installation using 10mm coarse aggregate

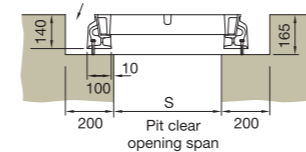

Type DMG

### Single gratings with shutter plates

Pit clear opening sizes	Grating type	Overall frame size length x width x depth	Suggested rebate size length x width x depth	Waterway pre unit
914 x 310	DRG/140/S	950 x 480 x 140	1065 x 700 x 165	1256cm <sup>2</sup>
914 x 457	DRG/140/S	950 x 630 x 140	1056 x 850 x 165	2215cm <sup>2</sup>
914 x 610	DMG/S	950 x 780 x 140	1065 x 1000 x 165	2768cm <sup>2</sup>

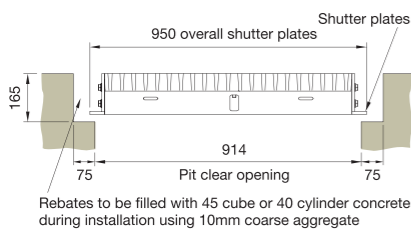

Rebates to be filled with 45 cube or 40 cylinder concrete during installation using 10mm coarse aggregate

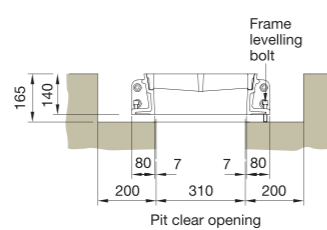

Type DRG/140/S - DMG/S similar

## Special range of drainage gratings



### Trench gratings and frames

Gatic gratings and frames can be manufactured in continuous runs.

A layout drawing with enquiries will enable our technical department to design an appropriate layout of gratings.



### Trench gratings

Pit clear opening sizes	Grating type	Overall frame size length x width x depth	Suggested rebate size length x width x depth	Waterway per metre
300	DRG/100	1000 x 480 x 100	L x 600 x 125	1813cm <sup>2</sup>
450	DRG/100	1000 x 630 x 100	L x 750 x 125	2629cm <sup>2</sup>
600	DRG/100	1000 x 780 x 100	L x 900 x 125	3445cm <sup>2</sup>
750	DRG/100	1000 x 930 x 100	L x 1050 x 125	4329cm <sup>2</sup>
810	DRG/100	1000 x 990 x 100	L x 1150 x 125	4466cm <sup>2</sup>



Rebates to be filled with 45 cube or 40 cylinder concrete during installation using 10mm coarse aggregate

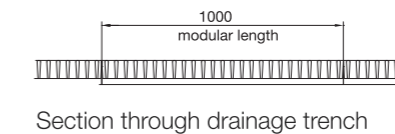
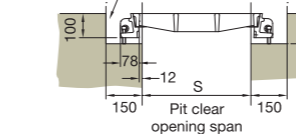

Section through drainage trench

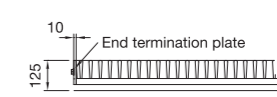

Section through end termination

### Plug covers

Loading groups up to C250

Small insert plug covers can be fitted to a wide range of cover sizes. Maximum 300 x 300 plug clear opening.

Refer to Gatic technical department for more information.

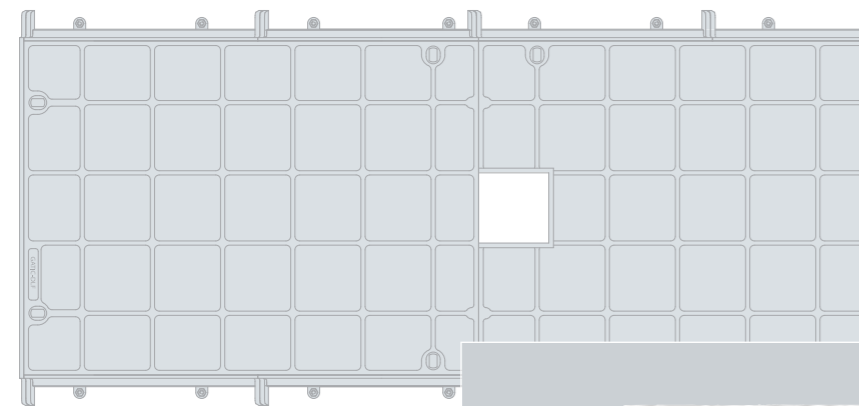
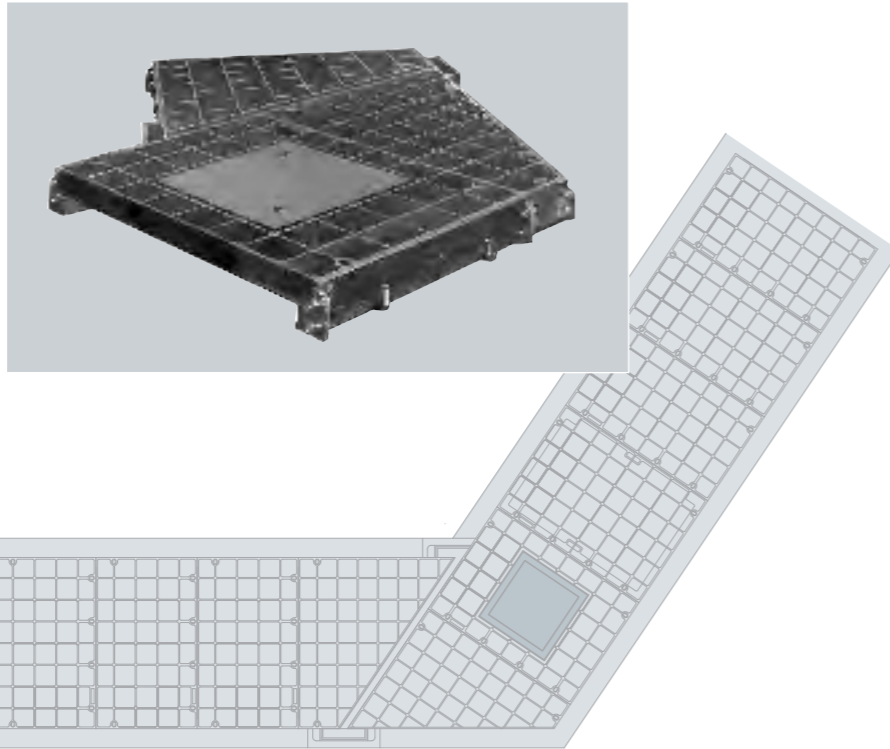

### Holes and cut-outs

Holes and cut-outs can be provided in covers to allow for the positioning of valves, pipes and cables. These can be square or circular, loading suitable for C250.

Upstands can be fitted to prevent the ingress of water around pipes and valves.



## Installation

### Single cover and frames

- 1 Prepare the rebate in accordance with dimensions given in the relevant tables within this publication and/or accompanying drawings.
- 2 Remove cover from frame and place frame squarely over pit ensuring it does not overhang any edges.
- 3 Screw down on the frame leveling bolts until the desired height is achieved.
- 4 Place formwork around inside of pit so that the timber is approximately 10mm above the bottom of the frame. This will prevent spalling of the frame.

Do not pour concrete at this stage.

- 5 Clean off cover and frame sealing faces and replace cover into frame.
- 6 Adjust the frame level so that the cover is not rocking. Tap down the corners of the covers with a balk of timber to make sure it is seated fully.
- 7 If covers are of the recessed design you will need to cover the 4 holes in the cover base with a small metal or slate plate.
- 8 Insert the plastic keyhole plugs and mask off with tape.
- 9 Pour concrete in the covers, if of the recessed type, and around the frames making sure that you thoroughly tamp and vibrate as you go.
- 10 Allow concrete to cure overnight.
- 11 Remove cover and strike shuttering.
- 12 Clean faces of covers and frame and apply a thin film of graphite grease to the seating faces.
- 13 Replace cover into the frame and tap down with a balk of timber.
- 14 Allow the concrete to fully mature before any load is applied.

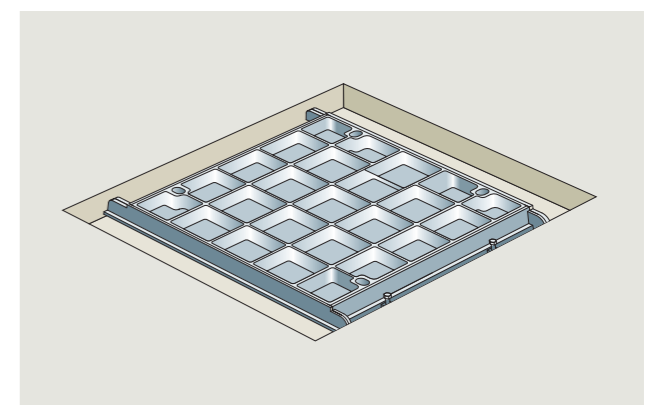
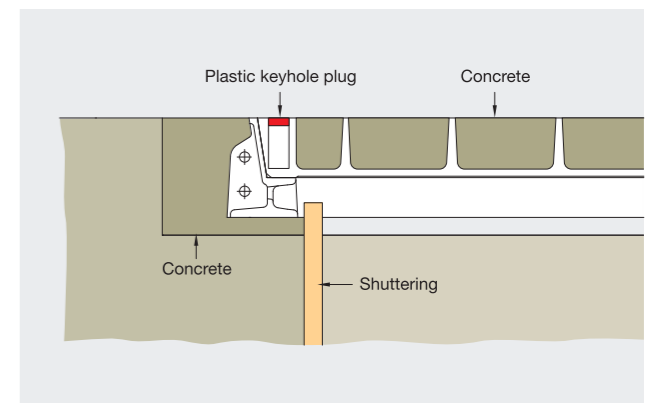
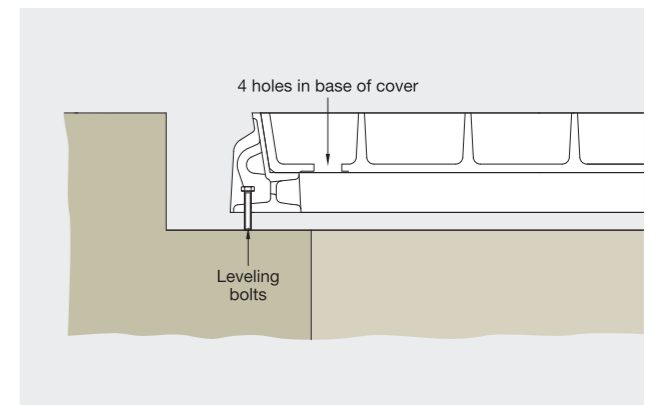
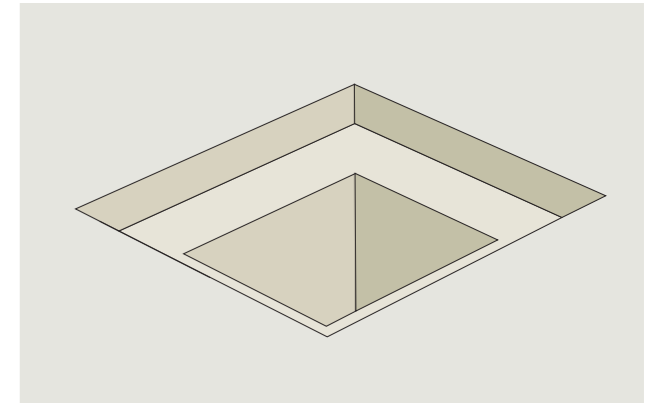

# GATIC

## Installation

### Ducts and trenches

- 1 Prepare the rebate in accordance with dimensions given in the relevant tables within this publication and/or accompanying drawings. They are also numbered in sequence.
- 2 Covers and frames are supplied pre-matched and banded together.

Do not remove banding at this stage.

- 3 Commence at one end of the pit, or if there is a junction then commence at this point. Identify the relevant covers and frames at this location.
- 4 Place first assembled section squarely over the pit ensuring it is in alignment with the centre of the pit.
- 5 Identify the next assembly. This is done by locating the next number in the sequence, offering up to the first portion and loosely bolting the frame together. Numbers are painted on the ends of the covers to correspond with the drawings supplied.
- 6 Adjust the height of the frames to the required level by using the leveling bolts in the frame.
- 7 Repeat along the length of the trench making sure the covers are following a straight line.
- 8 Visually check that your covers are in the correct frames and order by looking for the random grinding nicks around each cover perimeter on the top surface.
- 9 In sections, remove covers from frames and place formwork around inside of pit so that the timber is approximately 10mm above the bottom of the frame. This will prevent spalling of the frame.

Do not pour concrete at this stage.

- 10 Clean off covers and frame seating faces and replace cover into the frame.
- 11 Check that the grinding nicks still correspond.
- 12 Adjust the frame level so that the cover is not rocking. Tap down the corners of the covers with a balk of timber to make sure it is seated fully.
- 13 Using the assembly clamps provided, clamp the covers to the frames and across cover to cover joints. This will ensure that the covers are seated properly.
- 14 Moving round the frame, with the covers in place, tighten the frame bolts making sure you do not damage the lead packers or over-tighten the bolt.
- 15 If covers are of the recessed design, you will need to cover the small holes in the cover base with a small metal or slate plate.

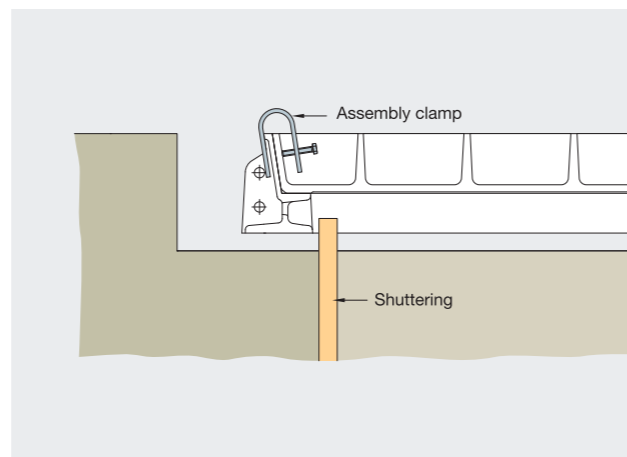
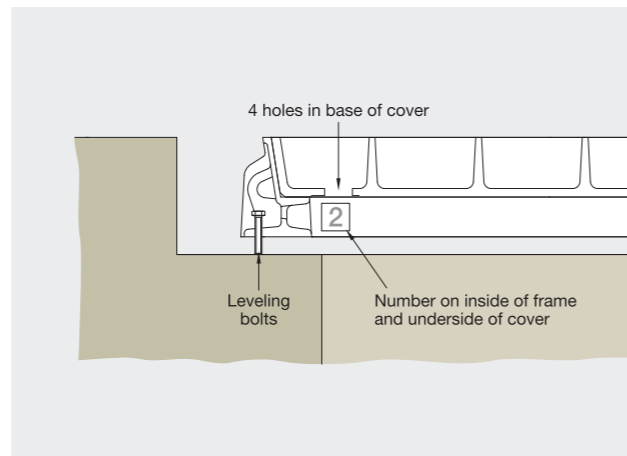
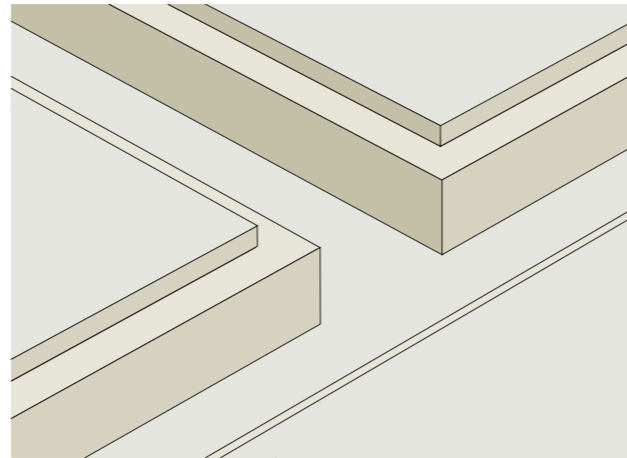

## Installation

### Ducts and trenches (continued)

- 16 Insert the plastic keyhole plugs and mask off with tape.
- 17 Pour concrete around the frames to a depth of about 25mm up the back of the frame and tamp or vibrate as you go.
- 18 Allow to cure overnight then remove the assembly clamps.
- 19 Pour concrete into the recessed covers, and around the frames, making sure that you thoroughly tamp and vibrate as you go.
- 20 Allow concrete to cure overnight.
- 21 Remove cover and strike shuttering.
- 22 Clean faces of covers and frame and apply a thin film of graphite grease to the seating faces.
- 23 Replace cover into the frame and tap down with a balk of timber. Once again make sure that the grinding nicks match up.
- 24 Allow the concrete to fully mature before any load is applied.

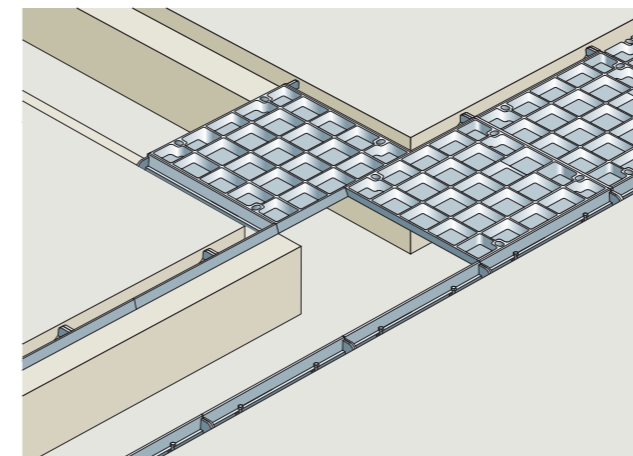
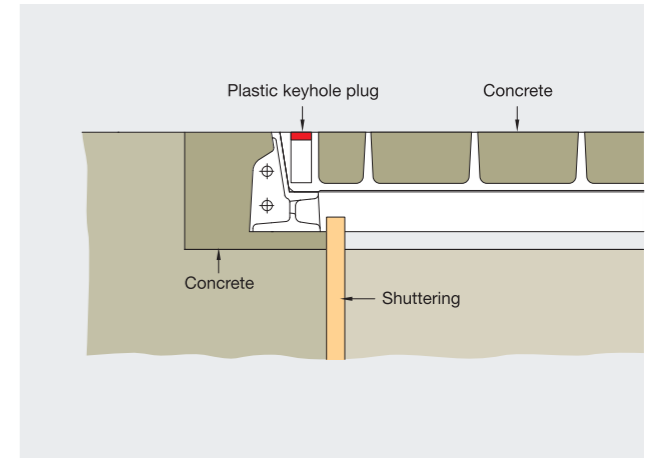

# GATIC

## Installation

### Multispan covers and frames

Form the frame and wallbox rebates around the pit strictly in accordance with Gatic's drawing. It is important to follow the stated dimensions otherwise the multispan cover will not fit.

The frame is delivered in sections together with beam assemblies and covers. Ensure that the end frames match with the side frame components.

The end frames can be identified as those sections with the beam end wallbox forming part of their construction. Frame sections and beam assemblies are numbered to help locate the cover positions.

Identification numbers are shown on the cover layout drawing supplied. Numbers can be found painted on the ends of covers, beams and outside faces of frames. Number tags are also fixed to the underside of the cover and also to the frame and beams.

The lowest numbers in each row of covers indicate that this is the front end of the unit.

- 1 Position the front end frames in the wallbox pockets and loosely join the sections together in the middle and at the corners.
- 2 Locate the side frame assemblies. These are handed so that they only fit on the correct side of the cover, and offer up to the back end frames.

Remember that there are a number of small frame pieces that make up a straight frame.

- 3 Check that lead spacers at the frame joints have not been damaged otherwise the frame will no longer mate with the cover. Again loosely bolt the frames together.
- 4 Using the large 'Tommy Bar' gradually screw down on the levelling bolts on the bottom of the wallboxes until the top of the frame is approximately level with the finished floor level.
- 5 Now using the small 'Tommy Bar' adjust the side frames up to approximate finished level.
- 6 Locate the correct beam assembly, look for the numbers painted on the beam and corresponding tags on the frame, and lower into the wallboxes.
- 7 Tap down on the filler block, using a rubber mallet, and then, using the small assembly clamp, clip the end of the beam into the wallbox. (If the filler block is not flush then the beam is not seated correctly in the wallbox and you will need to adjust it accordingly).
- 8 Dimensionally check the frame is roughly square and not overhanging the edge of the pit.

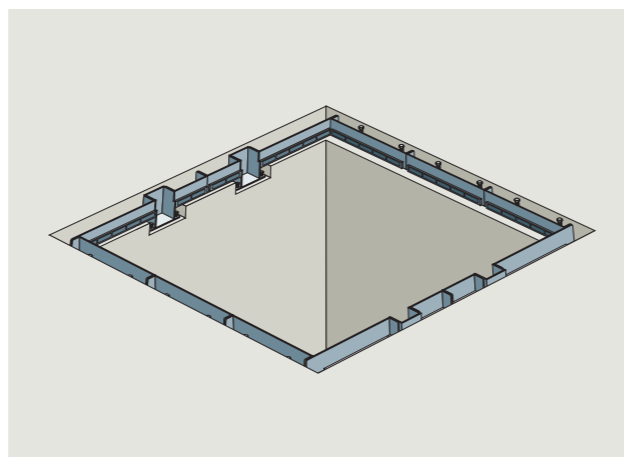
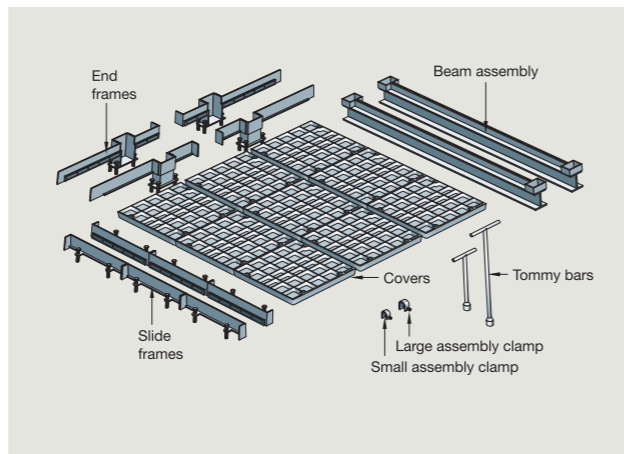
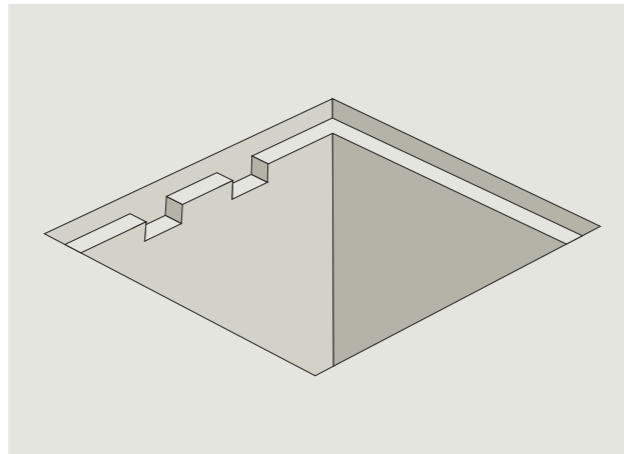

## Installation

### Multispan covers and frames

(continued)

Do not pour concrete at this stage.

- 9 Clear any debris from the seating faces of the covers and frames and, starting with the middle row, lay the three covers down between the two beams.
- 10 With the three covers in position, adjust the wallbox levelling bolts to attain the required height, and also to make sure that the covers are seated correctly and not rocking.
- 11 Position one of the outer rows and this time adjust the levelling bolts until the covers do not rock.
- 12 Repeat for the other end row.

The covers are now sound enough to walk on to check that they are not rocking.

- 13 Walk across the covers and tap the corners with a balk of timber to ensure that they are firmly down.
- 14 Using the assembly clamps provided, you can now pull the covers tightly together and into the frames to ensure the unit is correctly seated.
- 15 Visually check the top edges of the covers and frames making sure that random grinding marks align with each other.
- 16 Now go round the frame and tighten all loose connected frame joints, but do not over-tighten. They only need to be nipped up.
- 17 Remove the covers and carefully stack at the side of the pit.
- 18 Place timber shuttering around the inside perimeter of the pit and brace as appropriate. The shuttering should sit approximately 10mm higher than the bottom of the frame.
- 19 Replace the covers, taking care that they are in the correct location, check that there is still no rock, and then clamp the covers in place as before.

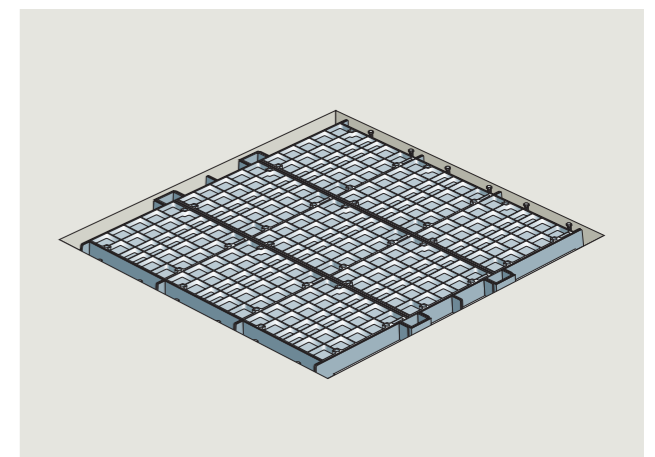
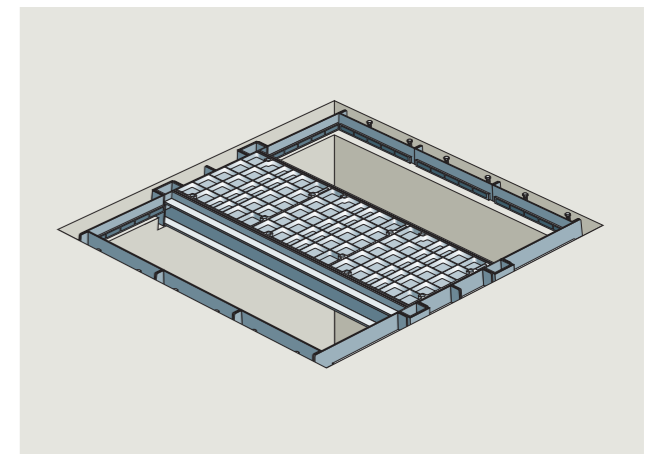
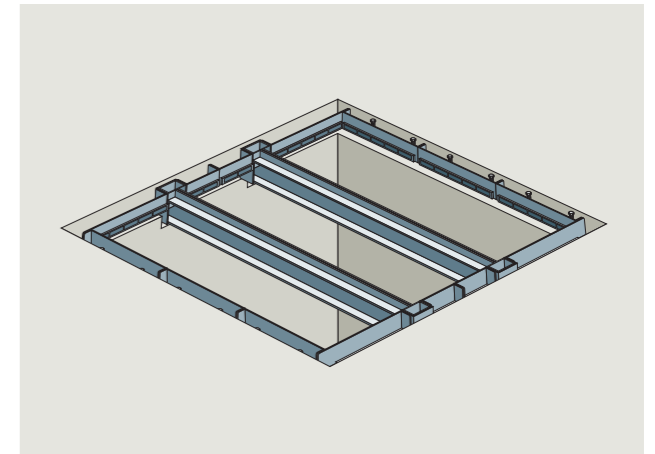

# GATIC Installation

## Multispan covers and frames

(continued)

- 20 Place small thin pieces of cut steel over the holes in the cover base plates, insert keyhole plugs and place masking tape over them.

The cover is now ready to receive concrete.

- 21 Leave the assembly clamps in place and part fill the rebate around the frame, going approximately 25mm up the back of the frame and thoroughly tamping or vibrating to ensure that it flows under the frame. Leave for 24 hours to set.

- 22 Remove clamps and proceed to infill around the rest of the frame and inside the covers, thoroughly tamping as you go.

- 23 Float off the surface to the desired texture.

- 24 Remove covers from the frames and strike the shuttering, checking that the concrete has fully flowed under the frame.

- 25 Clean off covers and beams.

- 26 Lightly grease the blocks on the end of the beams and place in position.

- 27 Lightly grease faces and covers and replace in frames, checking that the grinding marks align.

- 28 Allow the concrete to fully mature before any load is applied.

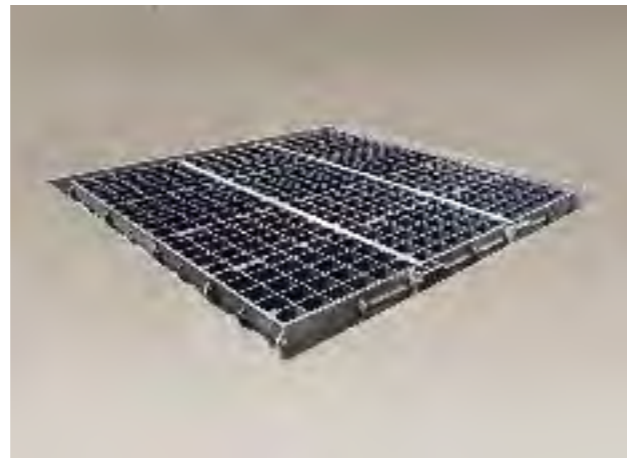
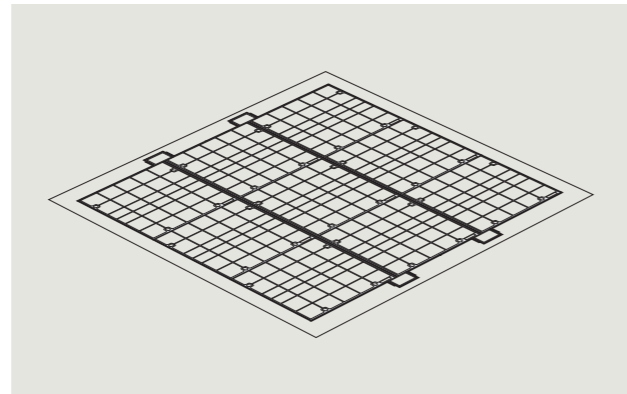

## Gatic tutorial

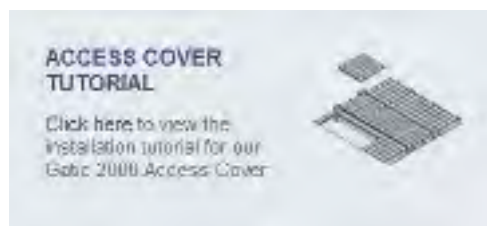

A Full tutorial on how to install Gatic Covers is shown on our website [www.gatic.com](http://www.gatic.com)



## Lifting keys



### Lifting keys

#### Manual jack screw key operation.

Method of removing Gatic covers using manual lifting keys.

- 1 Clear all obstructions from key holes.
- 2 Slacken off jack screw before placing key in position.
- 3 Insert tee bolt in the key hole, turn clockwise through 90° and tighten lock nut.
- 4 Jack screw can now be tightened to act on the frame and break seal.
- 5 Lift front and slide out cover.
- 6 Slacken off jack screw before replacing cover.

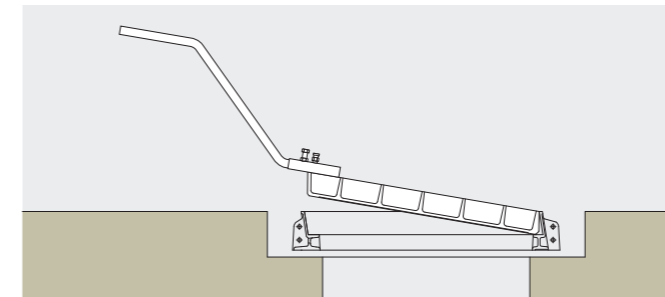

### Long handled lifting keys (pair)

Not for use with mechanical or crane lifting.

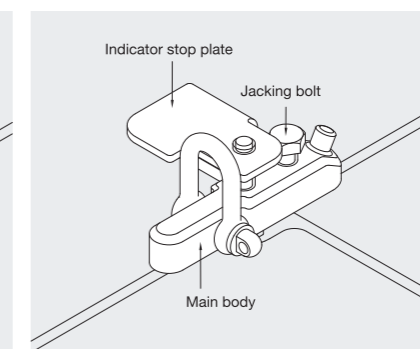
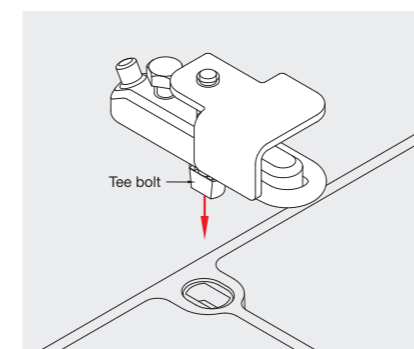
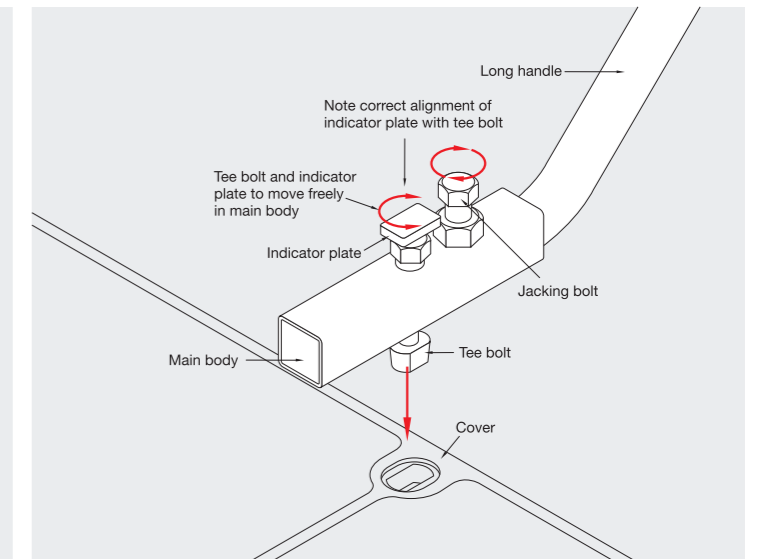
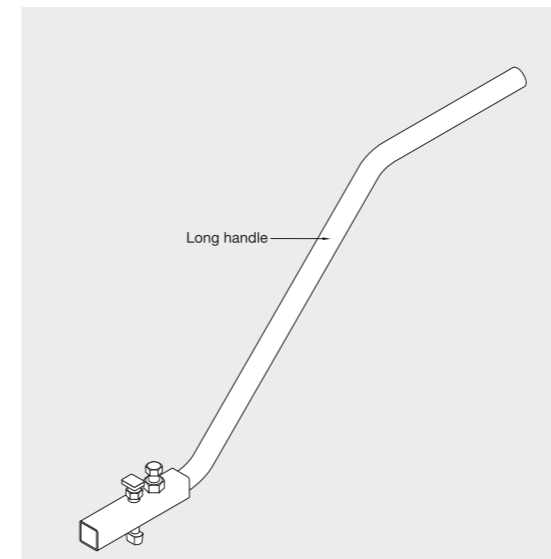

### Mechanical lifting keys

Mechanical lifting keys are designed and tested for use with crane and other mechanical devices.



# GATIC<sup>®</sup>

**AIC INFRASTRUCTURES PVT. LTD.**

GATIC  
Poulton Close  
Dover  
Kent CT17 0UF  
United Kingdom  
**INDIA**

Tel no: +44 (0) 1304 203545  
Fax no: +44 (0) 1304 215001  
email: [info@gatic.com](mailto:info@gatic.com)  
website: [www.gatic.com](http://www.gatic.com)

Corporate Office : A-01 / 101, Krishna Apartments,  
Juhu Lane, Andheri (W), Mumbai - 400058  
Tel: - 022-26708007 / 26708009  
Email :- [aic@aicinfra.com](mailto:aic@aicinfra.com) | Website :- [www.aicinfra.com](http://www.aicinfra.com)

Copyright GATIC - March 2011

GATIC is a division of Alumasc Ltd